

**APPLICATION OF CAPILLARY ELECTROPHORESIS FOR THE
DETERMINATION OF ORGANOARSENICALS IN POULTRY FARM WATERS**

by

ARAMIDE LOIS TAIWO

A THESIS SUBMITTED IN PARTIAL FULFILMENT OF THE REQUIREMENTS FOR
THE DEGREE OF MASTER OF SCIENCE IN ENVIRONMENTAL SCIENCE

In the Department of Chemistry

Thesis examining committee:

Kingsley Donkor (PhD), Professor and Thesis Supervisor

Department of Physical Sciences (Chemistry)

Heidi Huttunen-Hennelly (PhD), Associate Professor and Committee member

Department of Physical Sciences (Chemistry)

Dipesh Prema (PhD), Senior Lecturer, Committee member

Department of Physical Sciences (Chemistry)

James Kariuki (PhD), External Examiner,

University of Alberta, Augustana Campus

April 2020

© Aramide Taiwo

THOMPSON RIVERS UNIVERSITY

(Kamloops)

ABSTRACT

One way in which arsenic is introduced into the environment is through organoarsenicals. Organoarsenicals are used as feed additives in animal feeding operations. In poultry birds, they prevent diseases and accelerate growth. Examples of these organoarsenicals are roxarsone, arsinilic acid, nitarsone and carbasone. With poultry, consumption of organoarsenicals pose no health threat as 95% are excreted unchanged but the degradation products - arsenics, are toxic when accumulated in the human body system and can cause acute poisoning and cancer. This also leads to arsenic contamination in the environment - groundwater, air and consumer products have endangered the health and safety of millions of people around the world. Over the years, several analytical methods have been employed to determine the presence and concentration of organoarsenicals, however, they have some major drawbacks such as difficulty in measuring low concentrations and low selectivity. This research explores the development of a method using capillary electrophoresis (CE) with ultraviolet detection to determine the presence and concentrations of organoarsenicals in environmental water near poultry farms in Kamloops, British Columbia.

The effects of type, pH and concentration of background electrolyte on the separation were investigated in order to determine the optimum condition that would enable the detection of low concentrations of the organoarsenicals in environmental water bodies. This optimization allowed for successful and simultaneous baseline separation of roxarsone and nitarsone in water samples from the trough, well and tap water samples at the poultry farm waters. Using the technique of large volume sample stacking in CE, lower limits of detection and quantification were obtained for both roxarsone and nitarsone and further lower limits of detection were observed from preconcentration by applying the solid phase extraction.

Keywords: Roxarsone, nitarsone; large volume sample stacking, capillary electrophoresis, environmental water, poultry, organoarsenicals.

ACKNOWLEDGEMENTS

I would like to thank my parents Mr. and Mrs. Taiwo-Adeyemo, who have sacrificed so much for my brothers and I, especially fully supporting me and encouraging me in my second attempt at a master's degree. I deeply appreciate your love and do not take it for granted. Big thanks to Paul and Silas, my beloved brothers who have been there for me forever, I think about you both and I am pushed to do more and set a great example.

Special appreciation to my fiancé, Samuel Osho, who has been a huge source of encouragement especially in the latter part of my program. You came at the right time. I love you deeply.

I sincerely appreciate Dr. Kingsley Donkor who has been more than a research supervisor to me in my master's program. The immense support I have received in the past two years is beyond what I anticipated from a supervisor. Thank you for the opportunities provided throughout the course of my research for me to learn and be a better researcher and chemist.

I appreciate my research committee, Dr. Heidi Huttunen-Hennelly and Dr. Dipesh Prema for their unwavering support.

Special thanks to the chemistry department and the coordinator of master's in environmental science program, Dr. Wendy Gardner, for her support in the past years.

I thank the TRU Chemistry department for resources. Finally, financial support from NSERC through Professor Donkor's NSERC Discovery Grant and Canada Foundation for Innovation is gratefully acknowledged.

*To my parents who have always believed in me,
And to everyone who is trying again after failing!*

TABLE OF CONTENTS

Abstract.....	ii
Acknowledgements	iii
Dedication.....	iv
Table of Contents.....	v
List of Abbreviations.....	x
List of Figures.....	xii
List of Tables.....	xv
CHAPTER 1: INTRODUCTION.....	1
Arsenic in the Environment.....	2
Exposure to Arsenic.....	2
Toxicity of Arsenic.....	2
FDA’s current perspective on arsenic levels.....	3
Organoarsenicals.....	3
Roxarsone.....	5
Nitarsone.....	7
Poultry and Arsenic.....	8
Organoarsenicals in the Environment.....	9
Biodegradation.....	10
Photo-transformation.....	11
Sorption into soil.....	11
Current and Prior Techniques for Analyzing Arsenic.....	11
Atomic Absorption Spectrometry.....	11

High Performance Liquid Chromatography.....	12
Thin layer Chromatography.....	12
Capillary Electrophoresis for Organoarsenicals in the Past-Challenges and Achievements.....	13
Advantages of Capillary Electrophoresis.....	13
Research Goals and Objectives.....	14
CHAPTER TWO. ANALYTICAL INSTRUMENTATION.....	15
Capillary Electrophoresis.....	16
Factors affecting Capillary Electrophoresis.....	18
Capillary Inner Diameter.....	18
Voltage.....	18
Temperature.....	18
Capillary Diameter and Joule heating.....	19
Electroosmotic Flow.....	19
Effect of pH on Electroosmotic Flow.....	22
Effect of Concentration of the Electrolyte.....	22
Electroosmotic Mobility.....	22
Apparent Mobility.....	23
Sample Injection.....	23
Buffer.....	23
Detectors.....	24
UV Conditions.....	25
Photodiode Array Detector.....	27

Fluorescence.....	27
Capillary.....	27
Power Supply.....	28
Capillary Electro-Separation Modes.....	28
Micellar Electrokinetic Capillary Chromatography (MEKC).....	29
Capillary Zone Electrophoresis (CZE).....	31
Capillary Isoelectric Focusing (CIEF).....	32
Capillary Electrochromatography.....	33
Capillary Isotachopheresis (CITP).....	33
CE versus HPLC.....	34
Reproducibility.....	35
Sensitivity.....	35
Sample Stacking.....	36
pH-mediated Sample Stacking.....	37
CHAPTER 3: MATERIALS AND METHODS.....	38
Instrumentation.....	39
Capillary Conditioning.....	40
Samples.....	40
Study Site.....	40
Calibration and Analysis of Samples.....	41
Preparation of Solutions.....	41
Background Electrolyte (BGE) Preparation.....	42

Preconcentration.....	44
Solid Phase Extraction (SPE).....	44
Types of Cartridges Tested.....	45
Polymeric Strong Cation Exchange.....	45
C18 cartridge (Reversed Phase).....	46
Polymeric Anion Exchange.....	46
Electrophoretic Procedure for Standards and Sample Analysis.....	47
Optimized CE Conditions.....	48
Large Volume Sample Stacking.....	48
CHAPTER 4. METHOD VALIDATION.....	50
Method Validation.....	51
Results of Optimization.....	51
Analysis by Normal CE.....	51
Analysis by LVSS.....	54
Analysis by LVSS and SPE.....	57
Percent Recovery Studies.....	57
Recovery Results.....	58
Intraday and Interday Precision Studies (%RSD).....	62
Limit of Detection (LOD) and Limit of Quantification (LOQ).....	66
Matrix Effect.....	66
Analysis of Farm Water Samples.....	68
CHAPTER 5. CONCLUSION AND FUTURE WORK.....	79
Conclusion.....	80

Future Work.....	80
References.....	82
Appendix.....	97
Appendix A: Method Validation Results.....	97
Appendix B: Electropherograms of Some Samples.....	104
Appendix C: Facts about Arsenic and Organoarsenicals.....	107

List of Abbreviations

AU	Absorbance Unit
BGE	Background Electrolyte
BW	Body Weight
C18	Carbon-18
CE	Capillary Electrophoresis
CZE	Capillary Zone Electrophoresis
DMA	Dimethylarsinic acid
EOF	Electroosmotic flow
EPF	Electrophoretic flow
FDA	Food and Drug Administration
g	Grams
HPLC	High Performance Liquid Chromatography
ICP – OES	Inductively Coupled Plasma-Optical Emission Spectroscopy
IEF	Isoelectric Focusing
ITP	Isotachopheresis
LD ₅₀	50% Lethal Dose
LOD	Limit of Detection
LOQ	Limit of Quantification
LVSS	Large Volume Sample Stacking
μ_{ep}	Electrophoretic mobility
M	Molar
mg/L	Milligram per Litre

min	minutes
mol	moles
MECK	Micellar Electrokinetic Capillary Chromatography
NIT	Nitarsone (4-Nitrophenyl-arsonic acid, C ₆ H ₆ AsNO ₅)
PDA	Photodiode Array
ppm	parts-per-million
ppb	parts-per-billion
ROX	Roxarsone (4-hydroxy-3-nitrophenylarsonic acid)
R ²	Linear correlation coefficient
RSD	Relative standard deviation
s	seconds
SPE	Solid phase extraction
SD	Standard deviation
UV	Ultraviolet
V	volt
V	voltage
v_{eo}	electroosmotic flow velocity
v_{ep}	electrophoretic velocity
v/v	volume per volume

List of Figures

Fig. 1.1. Skeletal structures of roxarsone (4-hydroxy-3-nitrophenylarsonic).....	7
Fig. 1.2. Skeletal structure of nitarsonic acid (4-nitrophenylarsonic acid).....	8
Fig. 1.3. Transformation of arsenic from organic to inorganic form by various biological and chemical processes.....	9
Fig. 2.1. Schematic diagram of capillary electrophoresis.....	17
Fig. 2.2. Electrophoretic mobility in a capillary tube.....	17
Fig. 2.3. Schematic diagram of electroosmotic flow.....	21
Fig. 2.4. Schematic diagram showing the reversal of electroosmotic flow.....	21
Fig. 2.5. UV detector optic layout	26
Fig. 2.6. Capillary tube in a cartridge.....	28
Fig. 2.7a. Structure of sodium dodecylsulfate.....	30
Fig. 2.7b. Structure of a micelle.....	30
Fig. 2.8. Schematic representation of a capillary zone electrophoresis.....	31
Fig. 2.9. Capillary zone electrophoresis.....	32
Fig. 2.10. Isoelectric focusing.....	33
Fig. 2.11. Flow chart of classification of capillary electrophoresis separation methods based on buffer type and mechanism.....	34
Fig. 3.1. Picture of capillary electrophoresis system in Prof. Donkor's research lab.....	39
Fig. 3.2. Aerial view of field site in Kamloops, British Columbia, Canada.....	41
Fig. 3.3. Flow chart for preparation of buffer.....	43
Fig. 3.4. A set up of solid phase extraction.....	45
Fig. 4.1. Electropherogram of nitarsonic standards	52

Fig. 4.2. Calibration curve of peak area of nitarsone versus nitarsone concentration.....	53
Fig. 4.3. Electropherogram of standards of nitarsone.....	54
Fig. 4.4. Calibration curve of peak area of nitarsone versus nitarsone concentration.....	55
Fig. 4.5. Electropherogram of roxarsone	56
Fig. 4.6. Calibration curve of peak area of roxarsone versus roxarsone concentration.....	57
Fig. 4.7. Roxarsone concentration versus the peak area of roxarsone from the standard addition method	67
Fig. 4.8. Nitarsone and roxarsone concentrations of farm waters from summer sampling.....	68
Fig. 4.9. Nitarsone and roxarsone concentrations of farm waters from fall sampling.....	69
Fig. 4.10. Electropherogram for tap water 1A (BGE - 20 mM sodium carbonate-sodium bicarbonate, pH 10.0, wavelength 214 nm).....	70
Fig. 4.11. Electropherogram for tap water 2A (BGE - 20 mM sodium carbonate-sodium bicarbonate, pH 10.0, wavelength 214 nm).....	71
Fig. 4.12. Electropherogram for well water 1A (BGE - 20 mM sodium carbonate-sodium bicarbonate, pH 10.0, wavelength 214 nm).....	72
Fig. 4.13. Electropherogram for well water 2A (BGE - 20 mM sodium carbonate-sodium bicarbonate, pH 10.0, wavelength 214 nm).....	73
Fig. 4.14. Electropherogram of analysis of trough water A (BGE - 20 mM sodium carbonate-sodium bicarbonate, pH 10.0, wavelength 214 nm).....	74
Fig. 4.15. Electropherogram of analysis of well water 1B (BGE - 20 mM sodium carbonate-sodium bicarbonate, pH 10.0, wavelength 214 nm).....	75
Fig. 4.16. Electropherogram of analysis of tap water 1A (BGE - 20 mM sodium carbonate-sodium bicarbonate, pH 10.0, wavelength 214 nm).....	76
Fig. 4.17. Electropherogram of analysis of well water 2B (BGE - 20 mM sodium carbonate-sodium bicarbonate, pH 10.0, wavelength 214 nm).....	77
Fig. 4.18. Electropherogram of analysis of trough B (BGE - 20 mM sodium carbonate-sodium bicarbonate, pH 10.0, wavelength 214 nm).....	78
Fig. A.1. Standard addition of nitarsone using LVSS sample 1 well.....	101
Fig A.2. Electropherogram of standard solutions of roxarsone.....	102

Fig. A.3. Electropherogram of nitarsonsone standard (2 ppm, 5 ppm, 10 ppm, 20 ppm, 50 ppm, 100 ppm).....	103
Fig A.4. Standard addition of nitarsonsone standard to well water A1.....	104
Fig A.5. Electropherogram of analysis of tap water 1A after solid phase extraction with the C18 cartridge.....	105
Fig A.6. Electropherogram of analysis of trough water A after solid phase extraction with C18 cartridge.....	106

List of Tables

Table 1.1. Some organoarsenic compounds and their structures.....	4
Table 1.2. Previous study of arsenic in poultry.....	6
Table 2.1. Modes of capillary electroseparation and the basis of separation.....	29
Table 3.1. Optimized conditions for analysis of roxarsone and nitarsons.....	48
Table 3.2. Large volume sample stacking method for separation of nitarsons and roxarsone.....	49
Table 4.1. Calibration data (concentration and peak area) for nitarsons standards.....	53
Table 4.2. Calibration data (concentration and peak area) for roxarsone standards.....	56
Table 4.3. Percent recovery of nitarsons results for five samples of the first set by CE with LVSS.....	59
Table 4.4. Percent recovery of nitarsons results for five samples of second set.....	60
Table 4.5. Results of percent recovery for nitarsons in first set of samples.....	61
Table 4.6. Results of percent recovery of nitarsons in second set of samples.....	62
Table 4.7 - First day of interday precision studies for roxarsone.....	63
Table 4.8. Second day of interday precision studies of roxarsone on CE.....	63
Table 4.9. Third day of interday precision studies for roxarsone on CE.....	64
Table 4.10. First day interday precision studies for nitarsons on CE.....	64
Table 4.11 Second day interday precision studies for nitarsons on CE.....	65
Table 4.12. Third day interday precision studies for nitarsons on CE.....	65
Table 4.13. LOQ and LOD of roxarsone and nitarsons by CE with LVSS method.....	66
Table A. 1. Calculation of LOD and LOQ for roxarsone.....	96
Table A. 2 Calculation of LOD and LOQ for nitarsons.....	96

Table A.3. Percent recovery calculations for 5 samples of the first set.....	99
Table A.4. First day intraday precision studies for peak areas and migration time of roxarsone.....	100
Table B.1. Estimates of lifetime average dose of arsenic species in adults and average daily dose in children (in micrograms per kilogram BW per day) resulting from consumption of turkey, based on sample characteristics.....	107
Table B.2. Total arsenic concentration in various food groups from Canada.....	109
Table B.3. Comparison of two arsenical poultry drugs, roxarsone and nitarson. Dosage rate and indication information are form the [Food and Drug Administration (FDA)].....	110
Table B.4. Human exposure to arsenic.....	111
Table B.5. Concentration of total arsenic poultry Litter from Various Studies.....	112
Table B.6. Federal Drug Administration Tolerances for Arsenic Residues in Foods.....	113
Table B.7. Estimates of inorganic, organic, and total arsenic intake assuming a mean concentration of 0.39 ppm total arsenic chicken liver tissue, and three possible ratios of liver to muscle arsenic concentrations.....	113
Table B.8. Comparison of total As concentration (geometric mean [GM]; 95% CI) and As speciation ($\mu\text{g kg}^{-1}$ fw) in chicken meat from this study and previous studies.....	114

CHAPTER 1
INTRODUCTION

Arsenic in the Environment

Arsenic is semi-metallic in nature and is usually present in the earth crust in forms of oxides or sulfides. It also occurs as a salt of iron, sodium, calcium, copper, etc. Arsenic is found in low concentrations in almost every part of the environment, including foods. Also, activities such as mining, smelting and some livestock agriculture contribute to the release of arsenic into the environment (Jones, 2007). Arsenic and its compounds are well known for toxicity and carcinogenicity. Humans exposed to arsenic from various sources such as food, water, occupational settings (Singh et al., 2007). Arsenic contamination of groundwater has been a major concern as millions of people are at risk of arsenicosis. Arsenicosis is a chronic illness resulting from drinking water with high levels of arsenic over a long period of time (such as from 5 to 20 years). It is also known as arsenic poisoning.

Ingestion of inorganic arsenic over a long period of time causes adverse effects in multiple systems. Organic forms however are less toxic than inorganic forms. The clinical manifestations of chronic arsenic exposure are skin exposure are skin lesions, cardiovascular disease, reproductive disease, diabetes mellitus, cancers of skin and lungs.

Exposure to arsenic

Arsenic can be exposed to humans through inhalation, absorption into the skin and ultimately by ingestion of drinking water, most commonly (Tchounwou et al., 2003). Arsenic in food occurs at a non-toxic level, it is also present in its organic form in such cases, which is non-toxic. Foods such as seafood, fish, algae are rich sources of organic forms of arsenic (Ratnaike, 2003). Poultry intake has been associated with increased level of arsenic concentration in urine, according to a study by Nigra et al., (2017). Milton et al. (2015) reported that the main source of chronic arsenic exposure is through drinking contaminated groundwater in Bangladesh. Chronic exposure to arsenic has also been linked to adverse pregnancy conditions in Bangladesh as well (Yang et al., 2003).

Toxicity of arsenic

Arsenic is a well-documented human carcinogen affecting human organs. Arsenic exerts its toxicity by inactivating up to 200 enzymes. The two worst affected areas in the world of arsenic

contamination are Bangladesh and West Bengal, India. The lethal doses, LD50 for oral administration to mice are as follows (Benramdane, 1999): Arsine: 3 mg/kg, arsenite [As(III)]: 14 mg/kg, arsenate [As(V)]: 20 mg/kg, monomethylarsonic acid (MMA): 700-2600 mg/kg.

FDA's Current Perspective on Arsenic Levels

Organoarsenicals are less toxic than inorganic arsenic species (Bednar, 2002), however, due to the ill-effects of arsenic, Canadian government has reduced the maximum allowable level from 50 to 25 µg/L. There is still an ongoing contemplation to reduce it further to 5 µg/L. With the allowable levels being reduced, there is a requirement for arsenic to be removed in water before such water can be used for human consumption. Exposure to Arsenic leads to its accumulation in the tissues, hair, skin, nail, etc. (Kapaj et al., 2006). The World Health organization (WHO) guideline states that the total arsenic concentration in drinking water must not exceed 10 ppb.

Organoarsenicals

Compounds of arsenic combine fairly easily with carbon and the resulting product with one or more As-C bonds are widely used in agriculture and plant protection (Swaran, 2015).

Table 1.1. illustrates organoarsenic compounds (Sigma Aldrich).

Table 1.1. Some organoarsenic compounds and their structures.

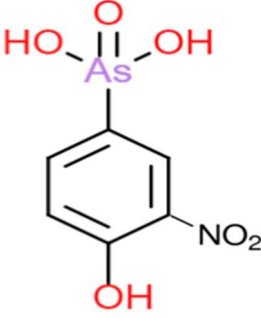
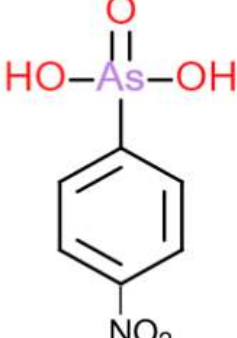
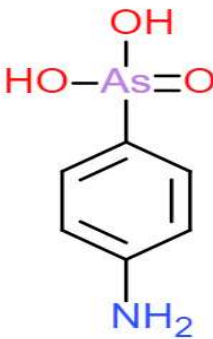
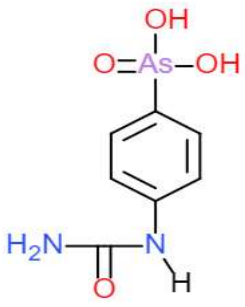
Organoarsenical	Chemical name	Structure
Roxarsone	4 – hydroxy-3-nitrophenylarsonic acid	
Nitarsonsone	(4-nitrophenyl)arsonic acid	
p-arsinilic acid	4-aminophenylarsonic acid	
Carbasone	[4-(Carbamoylamino)phenyl]arsonic acid	

Roxarsone

Roxarsone (4 – hydroxy-3-nitrophenylarsonic acid, ROX) is a non-toxic and water soluble organoarsenic additive used in poultry feed (Yao et al., 2019). In poultry, it promotes growth of animals and improves the feed-use efficiency (Chapman et al., 2002). Roxarsone was approved by the U. S. Food and Drug Administration (FDA) in 1994 to treat coccidiosis, which is a common intestinal parasitic disease in chicken), it also improves the feed conversion of these birds, thereby, causing them to gain weight much quicker (Silberberg and Nachman, 2008). The common dosage of Roxarsone ranges from 20.0 to 50.0 mg kg⁻¹ in poultry feed (Shui et al., 2016). Roxarsone has metabolites such as As(V), As(III), 3-amino-4-hydroxyphenylarsonic acid (AHPA) and some unknown species of As in aged manure. (Fisher et al., 2015). Other metabolites of arsenic include monomethylarsonate, dimethylarsinate and 4-hydroxyphenylarsonic acid (Rosal et al., 2005). Most of the roxarsone in the feeds is excreted unchanged in the manure (Garbarino et al., 2003) which is a waste disposed through land application, (Jackson et. al. 2003) and this is one way by which roxarsone enters the environment. The toxicity of roxarsone in the environment will largely depend on the species of the degradation product. (Vahter, 2002). A few studies have been made on the toxicity of roxarsone in the environment. In August 2011, roxarsone was banned in Canada. It is a derivative of phenylarsonic acid (C₆H₅As(O)(OH)₂). Before being used in poultry feeds, this compound is blended with calcite powder. Roxarsone is a major source of concern as an arsenic contamination. As a result of this concern, the use of roxarsone has been suspended in the U.S and Canada by the Food and Drug Administration (FDA). Typical dosage of roxarsone in poultry is 20-50 mg/kg feed (Jones, 2007). Roxarsone, administered in combination with ionophores and other antibiotics, including bacitracin and tylosin fights intestinal parasites and infections. Mortality rate in chicken that consume roxarsone are lower than those corresponding to chicken fed other antibiotics (Chapman and Johnson, 2002).

The breast meat from chickens exposed to arsenical feed additives contained about half a part per billion (Tavernise, 2013). Morrison (1969) examined the total arsenic concentrations in tissues and Wallinga (2006) studied chickens that received roxarsone or were assumed to have administered the drug. Some other studies were carried out on arsenic concentration in chickens and summarized by Nachman et al. (2013) in Table 1.2.

Table 1.2: Previous study of arsenic in poultry (Nachman et al., 2003).

Study	Analytical Method	Tissue	<i>n</i>	Total arsenic	iAs (µg/kg)
Morrison 1969	NR	Liver	181	150-790	N/A
Kidney	117	<100 – 240	N/A		
Muscle	181	<100	N/A		
Skin	144	<100			
Lasky et al. 2004	NR	Liver	20,559	330-430	N/A
Muscle (estimated)	20,559	NR	N/A		
Wallinga 2006	ICP-MS	Liver	151	ND - 21.1	N/A
Muscle (cooked)	90	ND – 46.5	N/A		
FDA 2011b	ICP-MS and IC-IC-MS	Liver	21	275 – 2940	0.1 – 9.1
Muscle (uncooked)	21	13.9 – 48.4	N/A		

Abbreviations: IC-ICP-MS, ion chromatography inductively coupled plasma mass spectrometry; ICP-MS, inductively coupled plasma mass spectrometry; N/A, not applicable; ND, not detected, NR, not reported. All chickens in this study by Morrison (1969) were treated with roxarsone, and the FDA study (FDA 2011b) was an experimental study using roxarsone-treated and control chickens; the studies by Lasky et al. (2004) and Wallinga (2006) were not

able to definitely determine which chicken samples had been treated with roxarsone. FDA 2011 results are for roxarsone-treated chickens with 5-day withdrawal period.

Roxarsone is reported to easily transform into other analogues of organoarsenicals including nitarsonsone, arsinilic acid, carbazone and other derivatives of phenylarsonic acid (Lu et al., 2014).

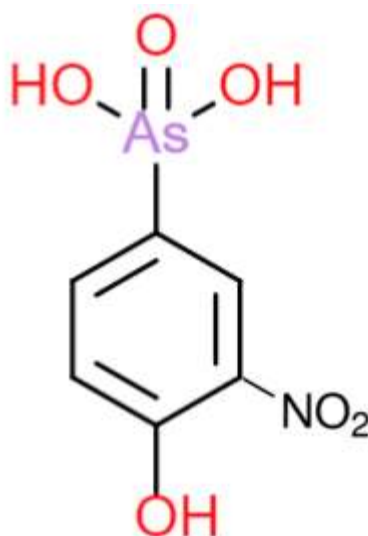

Fig. 1.1. Skeletal Structure of Roxarsone (4 – hydroxy-3-nitrophenylarsonic acid).

Nitarsonsone

Nitarsonsone (4- Nitrophenyl-arsonic acid, $C_6H_6AsNO_5$) is a phenylated arsenic compound that is used in poultry production as feed additive, just like roxarsone, it increases the weight gain, enhances feed efficiency, and prevents and treats *Histomonas meleagridis*, a protozoon that causes histomoniasis in turkey (Saucedo-Velez et al., 2017). Nitarsonsone shows low bioaccumulation potential and is largely excreted unexchanged. Poultry litter containing arsenic is saved and sold as fertilizer. This is one of the ways by which arsenic contamination from nitarsonsone is introduced into the soil, crops and water as the organic arsenic (i.e., nitarsonsone) undergoes biogeochemical degradation, leading to the transformation of stable organic arsenic into toxic inorganic arsenic compounds including arsenite As(III) and arsenate As(V), which pose a potential risk to the environment and to humans as well (Fisher et al., 2015). In a study by Keeve et al. (2014) involving analysis of turkey samples for total arsenic, it was observed that the nitarsonsone can expose turkey consumers to inorganic As and methylarsonic acid. The

results also showed that inorganic arsenic exposure was higher among samples of turkey which had no policies prohibiting nitarsone use compared to conventional producers who include nitarsone in the feeds. The skeletal structure of nitarsone is shown in Fig. 1.2.

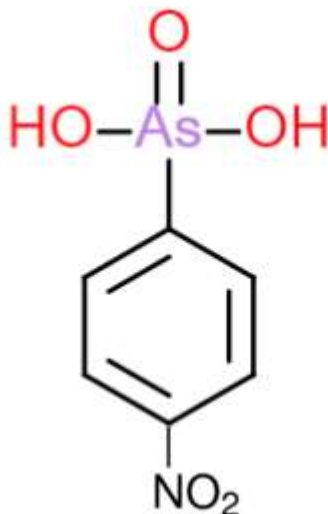

Fig 1.2. Skeletal structure of Nitarsone, (4-nitrophenyl)arsonic acid.

Poultry and Arsenic

Roxarsone has been used in poultry for nearly 60 years. Konkel (2016) reported a research conducted on large feeding trial of 1,600 chickens at the University of Alberta, Canada. In this trial, 800 chickens were fed with feeds supplemented with roxarsone which is commonly used in poultry production while 800 chickens ate controlled diet which did not include roxarsone. All chickens were fed without roxarsone to ensure that metabolites were eliminated from chicken breasts after exposure to roxarsone has stopped. This is a common practice with poultries which comply with FDA regulations. During the clearance period, it was found that arsenic species declined drastically in the roxarsone-free chickens while the levels of roxarsone, arsenite and some unknown species remained higher in the roxarsone group even 7 days after exposure ceased. Breast meat from roxarsone-fed chickens had 3.1 $\mu\text{g}/\text{kg}$ concentration of residual arsenite at the end of the study while the breast meat from the control chicken had 0.41 $\mu\text{g}/\text{kg}$ residual arsenite. The average daily intake of the chickens will be 0.01 $\mu\text{g}/\text{day}/\text{kg}$ body weight (Liu Q et al., 2016) for a 70-kg adult who ate about 3.5 oz of chicken per day. This is much lower than the WHO provisional tolerable daily intake value for inorganic arsenic of 3 $\mu\text{g}/\text{day}/\text{kg}$. Since they break down easily, in order to ensure confidence

in meat and egg industry, organoarsenical compounds used in animal feeds must be monitored (Rutherford et al., 2003).

Organoarsenicals in the environment

The presence of arsenic in environmental water depends largely on factors such as pH, redox of reaction, sorption and exchange reactions (Swaran, 2015). Arsenic is the most pervasive environmental toxic substance and as a result of its prevalence, every organism needs a level of immunity to inorganic arsenic (Li et al., 2016). It has been shown that chronic exposure to inorganic arsenic can lead to many serious diseases, such as hypertension, bronchitis, miscarriage, impaired biochemical process (Swaran, 2015), skin cancer, bladder cancer, and lung cancer (Hughes et al. 2011). The following figure shows the cycle of organoarsenicals in the environment.

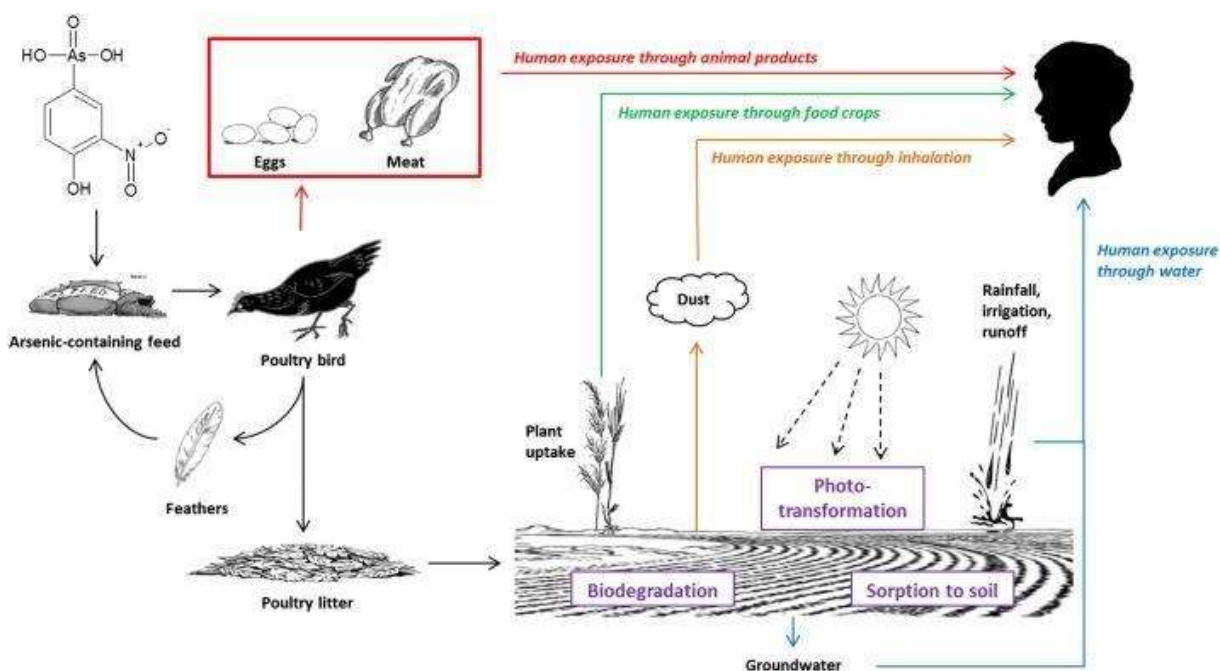

Fig 1.3. Transformation of arsenic from organic to inorganic form by various biological and chemical processes (Kiranmapayi, 2015).

Roxarsone is highly soluble, hence, it is mobile and can potentially partition between groundwater and surface waters (Stolz et al., 2007). As a result of reports such as this, it is essential to detect the amount of organoarsenicals contributed into environmental water so as

to treat it and prevent mobilization in the environment (Adak et al., 2015). Almost all of roxarsone added to animal feed is excreted into the manure and this eventually runs off into environmental water (Jackson et al., 2006).

One of the reduction products of roxarsone, aromatic amine, easily forms azides which are toxic and often carcinogenic (Bayse et al., 2013). Huge environmental risks are associated with the release of arsenic into the environment because non-poisonous organoarsenicals can readily transform into more toxic and much mobile forms of inorganic arsenic and these include arsenite and arsenate by hydroxyl radicals generated as reduction occurred in 10 mmol L⁻¹ Fe(II) and 50 mmol L⁻¹ tetrapolyphosphate under air atmosphere (Chen et al., 2019). The process of transformation occurs via biotic and abiotic processes especially in water bodies. It has been reported by Ashjaei et al. (2011) to contain total As and roxarsone concentrations of 40 and 1.07 µg/L, respectively, in a field amended with poultry manure.

Biodegradation

The bioconversion of roxarsone and other related N-substituted phenylarsonic and derivatives under anaerobic conditions (Cortinas et al., 2006). The results showed that roxarsone is rapidly transformed in the absence of oxygen to the corresponding aromatic amine, 4-hydroxy-3-aminophenylarsonic acid (HAPA). During long term incubation, this HAPA and the closely related 4-aminophenylarsonic were slowly biologically eliminated by up to 99% under methanogenic and sulfate-reducing conditions. Arsenite and lesser concentrations of arsenate were found to be the products of further degradation. Freely soluble forms of the inorganic arsenical species accounted for 19-28% of the amino-substituted phenylarsonic acids removed. Liu et al. (2016) conducted a study where poultry litter was incubated for 288 hours in the presence of roxarsone in dark aerobic conditions and observed that 94.5% of roxarsone was degraded after 48 hours, this shows that microorganisms are highly responsible for degradation of roxarsone.

Bacterial microorganisms such as *Shewanella putrefaciens* which is present in most environmental water, convert trivalent organoarsenicals including nitarsone, roxarsone and phenylarsenite into more toxic metabolites under anoxic conditions (Chen and Rosen, 2016).

Photo-transformation

The release of organoarsenicals into the environment is threatening because the organic species undergo photo-transformation into harmful inorganic species. The transformation occurs by UV-Visible light excitation (Li et al., 2016). On investigation, it was found that several factors influence the transformation of organoarsenicals, these include: pH, initial concentration, temperature. Karabult and Tapramaz (1999) and Xu et al. (2007) investigated the oxidation of PA by γ radiolysis under conditions that generates hydroxyl ion. They observed that the homolytic cleavage of the As-C bond resulted in the initial formation of As(III) and As(V) at approximately ratio 1:1 with As(IV) as an intermediate. This experiment describes the solar photochemical transformation of p-ASA which is an analogue of the organoarsenicals of interest. The degradation of roxarsone in poultry litter leachate was studied under various conditions and one of the observations was the photolytic cleavage of arsenite from roxarsone at pH 4-8 as experimentally shown by Bednar et al. (2002).

Sorption into soil

The major inorganic arsenic being introduced into soil and environmental water are arsenate [As(V)] under aerobic conditions and arsenite [As(III)] under anaerobic. The relative redox reactions between As(V) and As(III) are relatively slow, both oxidation forms are often found in soils regardless of pH and oxidation/reduction potential (Zhang and Selim, 2005). As(V) particularly has strong affinity for Sharkey clay. Adsorption of As in the soil also affects its moisture because moisture influences the adsorption of Arsenic into soil (Takahashi et al., 2004). Oxides and hydroxides of Fe and Al present in soil have high affinity to arsenic (Shipley et al., 2009), this is why plants like rice readily absorb inorganic As (iAs) from the soil (Liao et al., 2018), arsenate, for example, is universally taken into cells by phosphate transport systems (Yang et al., 2016).

Current and Prior Techniques for Analyzing Arsenic

Atomic Absorption Spectrometry

Atomic absorption spectrometry is an analytical technique that measures the concentrations of element by absorbing light at a characteristic wavelength. Samples are atomized and a beam

of electromagnetic radiation emitted from excited atoms is passed through the vaporized sample (Harris et al., 2019). Frahm et al. (1975) reported that this method demonstrates relatively high detection limits: 10 mg/L for flame AAS and 620 µg/L. These methods however are only capable of measuring total arsenic. They are not specific enough.

High Performance Liquid Chromatography

High performance liquid chromatography (HPLC) is a technique in analytical chemistry used to separate, identify, and quantify each component in a mixture. This technique relies on pumps to pass a pressurized liquid solvent containing the sample mixture through a column filled with a solid adsorbent material. Each component in the sample then interacts slightly differently with the adsorbent material, causing different flow rates for different components and leading to the separation of the components as they flow out of the column. HPLC is often coupled with mass spectrometry. This method, however, only separates three arsenicals using the cation exchange chromatography. Investigations are currently ongoing to investigate the applicability of this technique for more analytes and wider range of sample sources (Pergantis et al., 1997). Chen et. al., (2011) developed a high-performance liquid chromatography (HPLC) method for the detection for the simultaneous determination of arsinilic acid, roxarsone, nitarsone and carbazone in the feeds of swine and chicken and although this method was successful, it was found to be cumbersome and time consuming. Also, analytes get diluted when they stay longer inside the column which leads to smaller peaks and therefore less efficiency. Human organs (kidneys and livers) were frozen and analyzed for total arsenic presence using AAS by extracting with methanol/ water (1:1 by volume) and its metabolites monomethylarsonic acid (MMA) and dimethylarsinic acid which were separated using HPLC (Benramdane et al., 1999). Two methods were incorporated for the detection and separated because each method could not individually do both – a disadvantage.

Thin Layer Chromatography

Thin layer chromatography is a technique that separates a mixture into its chemical components in order to isolate one compound or to assess the purity of the mixture. It is an easy and versatile method. It also has low cost and is easily reproducible (Santiago et al., 2013). This technique was the first technique used in identifying organoarsenicals in feed additives.

However, the disadvantage is that the method is not capable of measuring organoarsenicals at environmentally relevant concentrations and are highly vulnerable to interference from background dissolved organic matter (Morrison, 1968).

Capillary Electrophoresis for Organoarsenicals in the Past – Challenges and Achievements

Capillary electrophoresis has also been used for analysis of arsenic and organoarsenicals. Speciation of arsenic by capillary electrophoresis using UV absorbance detection with on-line sample preconcentration was done by Lee et al. (2018) for water samples.

Rubio et al., (1995) reported the separation of organoarsenic compounds with atomic absorption spectrometry (AAS), inductively coupled plasma-optical emission spectroscopy (ICP-OES) coupled techniques and found that although these methods provide a good sensitivity, the complexity of the matrix hinders further separation and detection, also derivatization process had to be incorporated to detect lower concentrations of some species.

A high-performance liquid chromatography method coupled with UV detector was developed by Chen et al. (2011) for the simultaneous quantification of four organoarsenicals in the feeds of swine and chicken. In this experiment, 5 g of the feeds were digested, and several phases were investigated comprehensively for optimum LC separation. The method included ultrasonic solvent extraction and purification by clean-up solid phase extraction (SPE) for better selection, reproducibility and higher speed of analysis. Four organoarsenicals (arsinilic acid, carbasone, roxarsone, nitarsonic acid) were observed at 1.0 – 2.0 $\mu\text{g g}^{-1}$.

Advantages of Capillary Electrophoresis

Analysis time in CE is short (Xu et al., 1995) and automation is also easy. It is a very selective method of separation of high efficiency (Chen et al., 2003). Small volume of sample needed (Sato et al., 2004). The only disadvantage to capillary electrophoresis is its poor sensitivity to low concentration with UV detection (Jaafar et al., 2007), but this is improved upon using online preconcentration and large volume sample stacking.

Research Goals and Objectives

There is a need to ensure the amount of arsenic especially inorganic species released into the environmental waters do not exceed the permissible levels. There is a high demand for poultry by Canadian consumers. There is an even higher demand for pure water in lakes, wells and other supplies. The toxicity of arsenic makes it of great importance to develop a method to detect and quantify arsenic species in environmental waters. The research goals are as follows:

- Develop a method that is selective and sensitive for the simultaneous detection of roxarsone and nitarsone of low concentrations in the order of parts-per-million and parts-per-billion.
- Validate the method by parameters such as precision, selectivity, limit of detection and limit of quantification.

CHAPTER 2
ANALYTICAL INSTRUMENTATION

Capillary Electrophoresis

Capillary electrophoresis is an analytical technique that separates ions based on their electrophoretic mobility with the use of an applied voltage. The conducting buffer is retained within the capillary tube whose diameter is typically 25-75 μm . Samples are injected at one end of the capillary tube. As the sample migrates through the capillary, its components separate and elute from the capillary at different times. The time it takes a solute to migrate from the beginning of the capillary to the detector window is called the migration time (t_m). The trace of detector response versus time is called an electropherogram.

Electroosmotic flow (EOF) plays a major role in electrophoretic separations. Measurement of the electroosmotic force of a system ensures proper control of such system. (Melanson et al., 2001). The EOF decreases rapidly with pH and this makes the fast separation of mixtures of anions and cations at low pH more difficult (Liu et al., 2000). The EOF can be altered by change in pH and buffer added.

If the sample is placed in the anionic end of the tube i.e., the end with a positive charge, and an electric field is then applied across the liquid, the ions in the sample will tend to migrate through the tube at different rates. The rate and direction of migration depend on the sizes of the ions and the magnitudes and signs of their charges (Baker, 1995). Cations move faster than the electroosmotic flow, neutrals move at the same rate while anions move much slower, therefore, the order at which the analytes reach the negative electrode (cathode) is cations, neutrals, anions.

The electrophoretic mobility is dependent upon the charge of the ion, the viscosity and the ionic radius. Neutral species are not affected, only ions move with the electric field. If two ions are the same size, the one with greater charge will move faster. The rate at which the ion moves is directly proportional to the applied field which implies that the greater the field strength, the faster the mobility for the ion. A schematic of capillary electrophoresis technique is shown in Fig. 2.1. and the electrophoretic mobility is shown in Fig. 2.2.

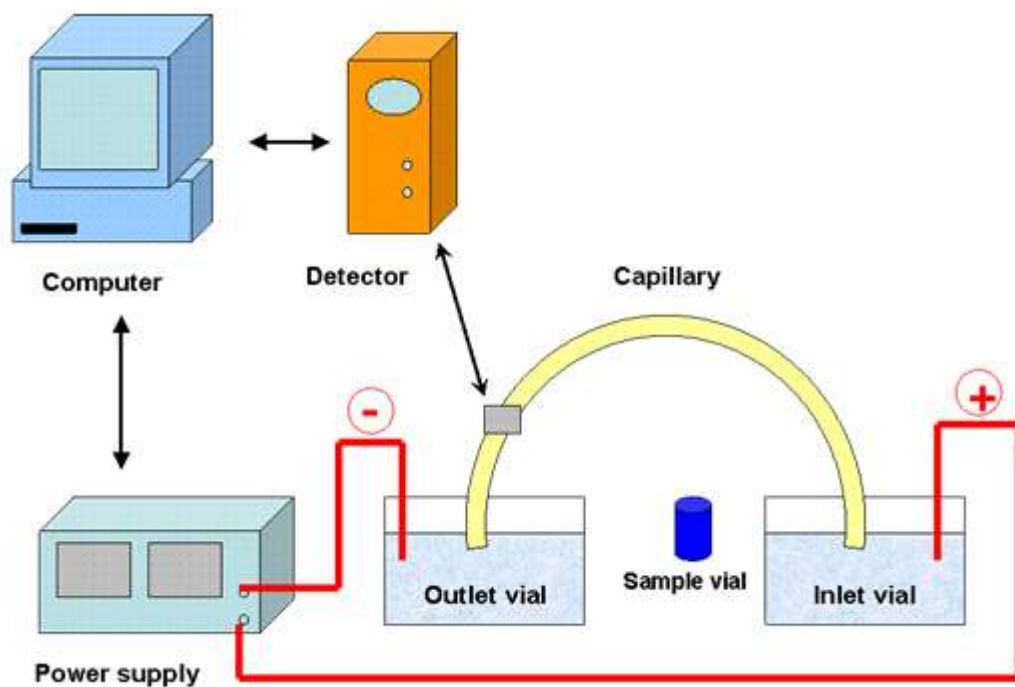

Fig 2.1. Schematic diagram of capillary electrophoresis (Adapted from Agilent Primer, 2000).

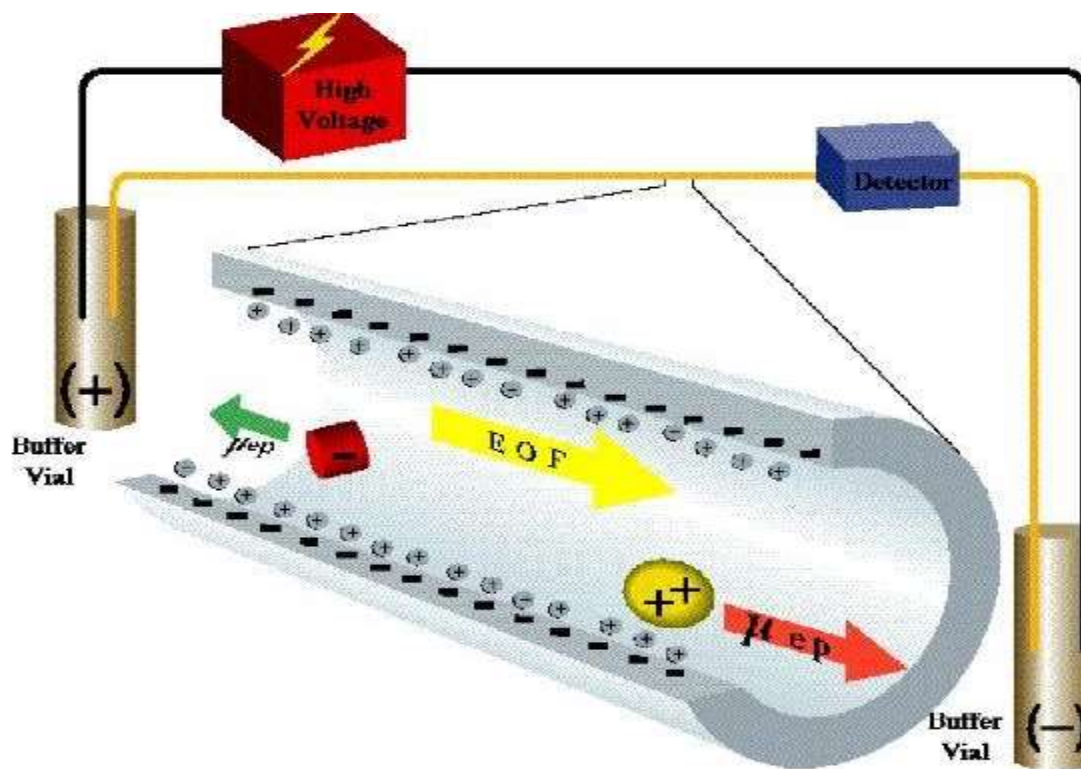

Fig 2.2. Electrophoretic mobility in a capillary tube. Indicate the source. (Adapted from Agilent Primer, 2000).

Factors Affecting Capillary Electrophoresis

Capillary Inner Diameter

An appropriate choice of capillary inner diameter (i.d.) can reduce the effects of Joule heating (Hutterer et al., 1999.). The inner capillary diameter ranges from 20 – 75 μm (Li et al., 1998). The roughness of the inner capillary typically ranges from 0.2 to 2 μm and this surface roughness affects electroosmotic motion (Horka, 2016). The diameter influences the efficiency and sensitivity of a capillary electrophoresis separation (Ilko et al., 2012). Smaller inner diameters have proven to provide more uniform heat distribution thereby reducing Joule heating (Heller et al., 1998).

Voltage

In capillary electrophoresis, especially zone electrophoresis, voltage is applied to the ends of the capillary (Zhang et al., 2002). The applied voltage significantly affects how fast the ions move during separation (Mudgett et al., 1992) and this in turn affects the peak time and the efficiency of separation (An et al., 2018). Running with a buffer (or background electrolyte, BGE) with high concentration and a high voltage leads to a decrease in peak current (Zhang et al., 2002).

The pH of the buffer defines the electroosmotic flow range as it can be optimized for resolution (Hayes et al. 1993). It also largely influences the electrophoretic mobility (Timperman et L., 1996). Doubling the concentration of the buffer doubles the amount of heat generated inside a column (Isaqq et al. 1991).

Temperature

During electrophoretic separation, Joule's heat is produced leading to temperature gradients in the CE system which is accompanied by gradients in density, viscosity and mobility, thus increasing dispersion. The mobility increases by two percent when the temperature is raised by 1°C. To reduce the resulting mixing by convection, the classical techniques use stabilizing media e.g., paper, cellulose acetate, starch but this has many disadvantages including; tedious detection, difficult quantification, time consuming, impossible automation. However, a new

approach is made to reduce the convective dispersion resulting from temperature gradients, this is to minimize the diameter of separation capillary (Baker, 1995).

The temperature difference, ΔT , between the center of the capillary and its wall is proportional to the square of the diameter of the capillary. The relationship is as follows:

$$\Delta T = \frac{d_c^2}{16.K}$$

where W is the rate of heat generation per unit volume within the cylinder, K is the thermal conductivity of the medium and d_c is the inner diameter of the capillary.

Capillary diameter and Joule heating

Joule heating is the heating of the electrolyte in a capillary causing dissipation of power (Rathore, 2004). Just as it is with capillaries, the degree to which temperature rises in the tube is a function of the quantity and the thermal and electrical properties of the fluid holds, while the efficiency of heat dissipation is primarily a function of channel geometry, substrate mass and cooling system design. Hence, the inner diameter of the capillary contributes largely to the rate of thermal dissipation (Swinney et al., 2002).

$$\frac{dH}{dt} = \frac{iV}{LA}$$

where L is the capillary length and A , the cross-sectional area. Since $i = \frac{V}{R}$ and $R = \frac{L}{kA}$ where k is the conductivity, then,

$$\frac{dH}{dt} = \frac{kV^2}{L^2}$$

The amount of heat generated is proportional to the square of the field strength. Either decreasing the voltage or increasing the length of the capillary has a dramatic effect on the generation of heat. Using low conductivity buffers is also helpful in such situation.

Electroosmotic Flow (EOF)

Electroosmotic flow is also sometimes referred to as electroosmotic mobility. On filling the buffer in the capillary, the buffer solution usually moves through the capillary under the

influence of an electric field, this phenomenon is called electroosmotic flow (Baker, 1995). Different types of ions move at different rates. Neutral solutes are not influenced by electrophoretic mobilities, and therefore move through the capillary at the same rate as the electroosmotic flow. Positively charged solutes migrate towards the negative electrode under the influence of both electrophoretic and electroosmotic flow, and so move faster than the electroosmotic flow. Charged solutes are separated from each other because of the difference in their electrophoretic mobilities. Neutral solutes are separated from charged solutes but not from each other. Electroosmotic flow is highly advantageous because without it, separating anions and cations cannot be done in one run, it would have to be done in separate runs. (Baker, 1995).

$$\mu_{eo} = \frac{u_{e0}}{\epsilon}$$

It can also be determined as

$$\mu = \frac{\epsilon\zeta}{\eta}$$

where ϵ is the dielectric constant of buffer

ζ zeta potential

η viscosity of buffer

The characteristics of buffer includes dielectric constant, viscosity, pH, concentration.

There are various factors that affect the velocity of EOF and the simplest of these is the change of composition of the background electrolyte (BGE) (Kok, 2000).

The inner surface of silica-fused capillary tubing contains large number of silanol groups (Si-OH). It is easy to understand that this surface will be electrically charged as a result of the dissociation of Si-OH (Pretorius et al., 1979) by ionization to SiO⁻ at pH greater than 2 (Xu, 1999). This ionization is improved by passing a basic solution (NaOH) through the capillary and then followed by a buffer. This is called capillary conditioning. The negatively charged silanoate ions attract and bind tightly to the positively charged cations from the buffer to form an inner layer that is fixed in the capillary. The cations are however not sufficient to neutralize

all the negative charges; hence the loose cations form another mobile layer and these two layers form the (electric) double layer. Electroosmotic flow is produced between the inner and the outer when the cations in solution drag the bulk solution towards the cathode. The potential gradient generated between the solid surface and the buffer is called the zeta potential (Hayes et al., 1997). Coating the capillary with non-ionic solution reduces the electroosmotic flow as shown in Fig. 2.4. The cations migrate from anode to cathode. A schematic diagram of reversal of electroosmotic flow is shown in Fig. 2.5.

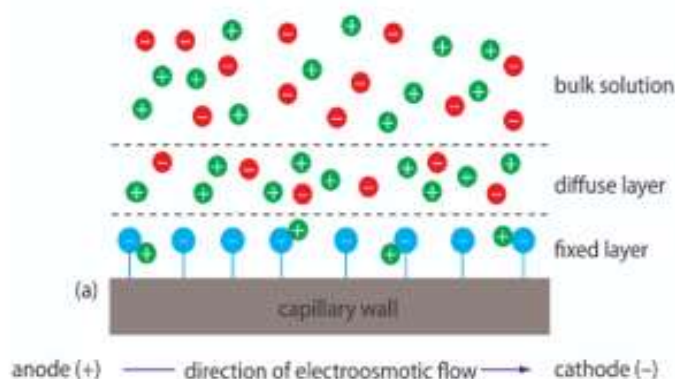

Fig 2.3. Schematic diagram of electroosmotic flow. (Adapted from Agilent Primer, 2000).

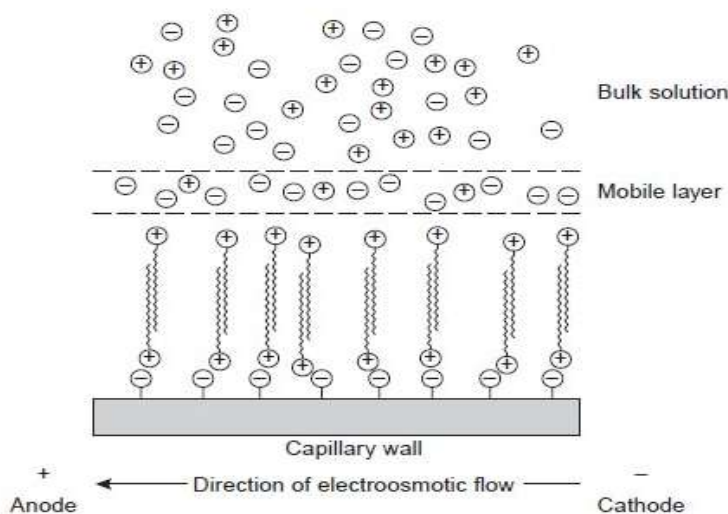

Fig 2.4. Schematic diagram showing the reversal of electroosmotic flow. (Adapted from Beckman Coulter handbook of capillary electrophoresis, Coulter, 2003).

Effect of pH on Electroosmotic Flow

The pKa values of silanol on the capillary surface range from 1.0 to 1.5. At pH higher than 8, most of the silanol groups on the inner surface of an uncoated capillary are dissociated and the velocity is hence not dependent upon the pH. At pH less than 4, the electroosmotic flow is not dependent on the pH because most silanol groups are not dissociated (Hayes et al., 1997).

Effect on concentration of the electrolyte

An increase in the concentration of the background electrolyte results in decrease in the electrophoretic velocity of the ions involved which is caused by change in electrophoretic mobility (Jumppanen et al., 1995).

Electrophoretic Mobility (μ_{ep})

Electrophoretic mobility is a solute's ability to move through a conductive medium, the buffer solution, in response to the applied electric field. Cations generally migrate towards the electric field's negatively charged electrode provided there are no other effects. Cations with larger size-to-charge ratio migrate at a faster rate than larger cations with smaller charges. Anions move towards the positively charged electrode. Neutral species do not respond to the electric field hence they remain stationary. The electrophoretic velocity of a solute is defined as follows:

$$V_{ep} = \mu_{ep}E$$

where μ_{ep} is the solute's electrophoretic mobility, and E is the magnitude of the applied electrical field. A solute's electrophoretic mobility is defined as

$$\mu_{ep} = \frac{q}{6\pi\eta r}$$

where

q is the solute's charge,

η is the buffer viscosity, and

r is the solute's radius,

$f = 6\pi\eta r$ - this is Stoke's equation.

From the equations above, we can conclude that electrophoretic velocity and consequently electrophoretic mobility increases for more highly charged solutes and solutes of smaller sizes. The greater the radius, the lower the mobility.

Apparent Mobility

The migration rate of an analyte in a capillary electrophoresis system which is referred to as apparent mobility is the sum of the electroosmotic mobility and its electrophoretic mobility (Thorslund et al., 2005). For an analyte cation moving in the same direction as the electroosmotic flow, μ_{ep} , and μ_{eo} , have the same sign, so is greater than μ_{ep} . Electrophoresis transports anions in the opposite direction from electroosmosis as in Fig. 2.3.

$$\mu_{app} = \mu_{ep} + \mu_{eo}$$

Fast electroosmosis transports anions to the cathode at neutral or high pH because electroosmosis is usually faster than electrophoresis and at low pH, the electroosmosis is weak and anions may not get to the detector. In order to separate anions at low pH, the polarity can be reversed to make the sample end negative and the detector end positive (Harris and Lucy, 2019).

Sample Injection

A sample is usually injected directly into a flowing liquid through the use of loop-valve injectors or syringes. In CE, the sample is ordinarily introduced into the capillary while there is not flow of buffer through the capillary (Baker, 1995). The sample is rather introduced into the system than injected. Samples can be injected by hydrodynamic injection or electrokinetically. Hydrodynamic injection demonstrated by Opeka and Tumar (2017), this is done by either pressure or gravity, where the sample flow is brought to a flow gate interval (FGI) by a syringe pump. A pressure difference is placed in between the capillary ends by applying some positive pressure on the sample vial and the flow of BGE turns the sample away from the injection end of the capillary. The pressure difference introduces the sample into the sample plug (Gong et al., 2018).

Electrokinetic injection, also called electromigration injection (Krivacsy et al., 1999), on the other hand uses the electric field to drive sample into the capillary. The capillary goes into the sample by immersion and voltage is applied at its ends (Harris and Lucy, 2019). The electroosmosis acts as a pump delivering a representative sample into the capillary (Huang et al., 1988).

Buffer

Buffers are most efficient when within one or two units of their isoelectric point. Buffer concentrations are usually between 10 mM and 100 mM. Increasing buffer concentration increases the ionic strength and this results in lowering of the electroosmotic flow. The buffer pH has a significant effect on the electroosmotic flow (EOF), because it changes zeta potential. As the pH of buffer increases, the electroosmotic flow also increases. The stability of the coating on the dynamic coating depends upon the pH of the buffer and this is optimum when pH is reduced from basic range to acidic range. At higher pH, there is more dissociation of silanol (Si-OH) groups into the ionic form Si-O⁻. At lower pH, the surface charge is lower and this results in lower zeta potential, hence, lower electroosmotic flow.

The optimum pH of the run buffer is near of slightly below the pKa values of solute of interest. Electroosmotic flow becomes significant above pH 4 (Frenz and Hancock, 1991).

Detectors

Detectors are an essential part of CE analysis, they play a major role in evaluating the analytical method (Kuban et al., 2018). There are several types of detectors which have been used in capillary electrophoresis so far. CE can be combined with a variety of detectors including ultraviolet spectrophotometry, mass spectrometry, chemiluminescence, electrochemical, laser-induced fluorescence (Wu et al., year). The most commonly used of these detections is the UV/Vis absorbance detectors. The detection limits for such range between approximately 1 mg/L (ppm) – 1 µg/L (ppb) which is just appropriate for this research. In UV-Visible absorption detection occurs from wavelength of 200 nm through visible spectrum without interference. The capillary itself is used as the sample holder and UV-Vis detector detects analyte as it passes through the capillary.

The detector must be carefully designed since the capillary tube is very thin and has a very tiny path length. The beam of light from the lamp must be of a small radius and focused on the capillary.

UV detection measures absorbance, A , of solutions as beam of light from the lamp pass through a path length, the unit of the corresponding output is AU. Transmittance is the fraction of light that passes through the sample and this is calculated using the following equation:

$$\text{Transmittance, } T = \frac{I_t}{I_o}$$

where I_t is the light intensity after the light beam passes through the sample and I_o is the light intensity before the beam of light passes through the sample. Transmission is related to absorbance by the following equation:

$$\text{Absorbance } (A) = -\log(T) = -\log\left(\frac{I_t}{I_o}\right)$$

This absorbance agrees with Beer's law:

$$(A) = -\log(T) = -\log\left(\frac{I_t}{I_o}\right)$$

where

ϵ is the extinction coefficient or molar absorptivity,

b is pathlength of cell in cm (the internal diameter of the capillary),

C is the concentration of solute.

Sensitivity of the method employed depends on the correctness of the wavelength established (Taylor, 2015).

UV conditions

UV absorption is the most common mode of detection in CE, this detection incorporated into the instruments. Fused silica capillaries are typically used, and aqueous buffers are employed for such analysis. The wavelength allowed range from below 200 nm up to the visible region

spectrum. Low wavelength improves sensitivity and applicability. Some charged analytes (i.e., cations and anions) lack strong UV absorption. Indirect UV detection is employed in such situations. A chromophore which binds to the compound is added to the background electrolyte (BGE) and this is displaced by the analyte. The peak appears reversed in the position of the analyte (de Jong, 2016) and is obtained by reversing the output polarity of the detector. A layout of UV detector optic is illustrated in Fig. 2.5.

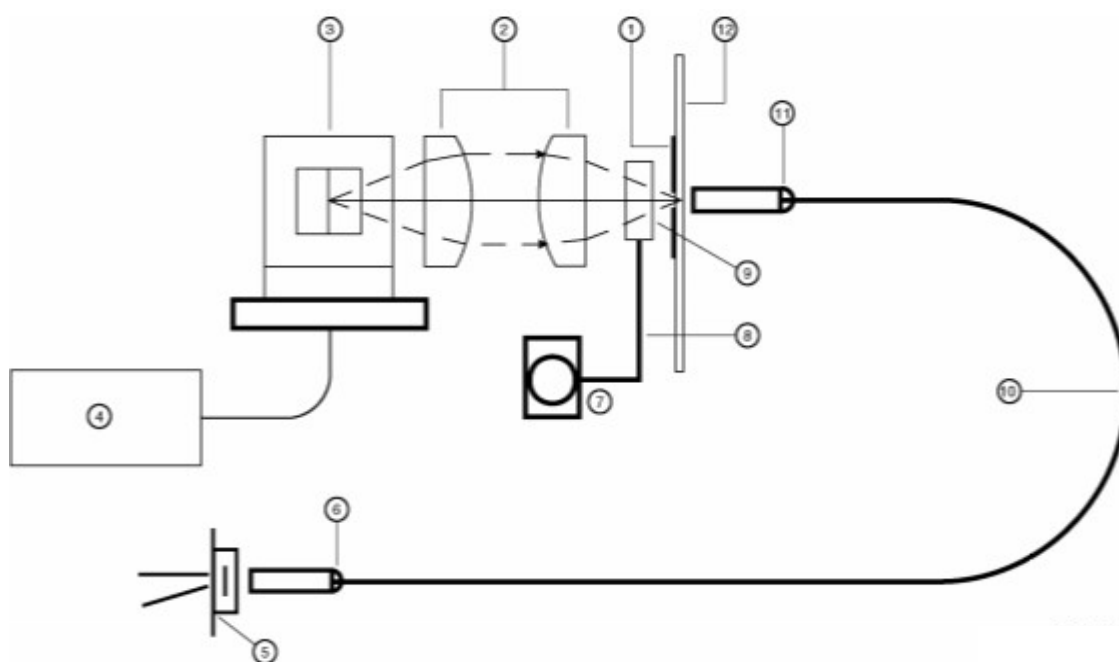

- | | |
|---------------------------|---|
| 1. Capillary Aperture | 7. Motor |
| 2. Lenses | 8. Position Filter Wheel |
| 3. Deuterium lamp | 9. Filter Position (for example 214 nm) |
| 4. Lamp power supply | 10. Fiber Optic Cable |
| 5. Photodiode | 11. Fiber Optic Connector |
| 6. Fiber Optic Connection | 12. Capillary |

Fig 2.5. UV detector optics layout.

(SCIEX, A. B. (2015). *P / ACETM MDQ plus Capillary Electrophoresis System*)

Photodiode Array Detector

The diode array detector is fast-scanning and has high resolution (Beck et al., 1993). In most capillary electrophoresis instruments, the PDA measures light similar to the UV detector. It converts the light signal into an electrical signal, (SCIEEX, A. B., 2015).

Fluorescence

Fluorescence is an optical system which can produce high sensitivity (Swinney et al., 2000). Laser induced fluorescence increases the detection sensitivity and limits of methods (Mazereeuw et al., 1995).

Capillary

Capillary columns are usually packed with packing materials (de Boer et al., 1999) such as fused silica. Some are made of Teflon and borosilicate glass. Fused silica is used more often because of its intrinsic properties which include transparency over a wide range of the electromagnetic spectrum, as well as high thermal conductance (Li, 2016; Schimpf, 1996). Fused silica is transparent to ultraviolet (UV) and visible (vis) light. Capillary lengths vary from 30-100 cm in length with inner diameters of 50-75 μm and outer diameters of 375 μm (Baker, 1995). The insides are usually negatively charged (Tran and Xu, 1998) because of the presence of the silanol groups and the interactions of analytes induces electroosmotic flow, this flow however, could be a disadvantage (Li, 2016; Sun and Armstrong, 2010). Capillaries are often cooled in order to reduce Joule heating thereby minimizing peak spreading which could result from thermal convection. A picture of the capillary cartridge used in this work is shown in Fig. 2.6.

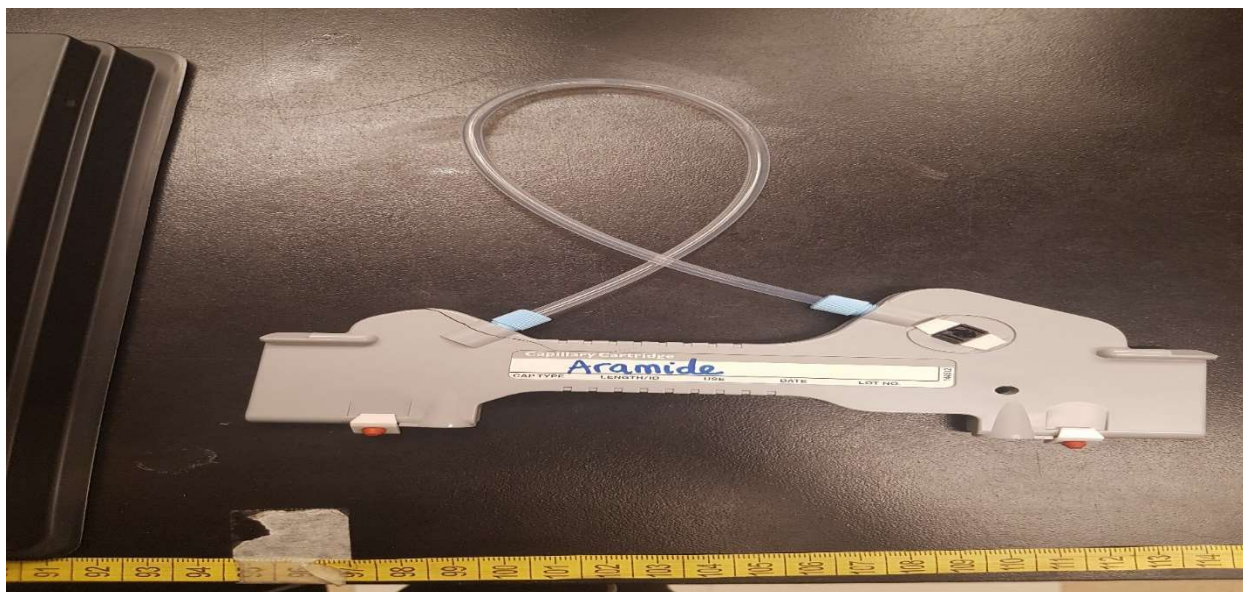

Fig 2.6. Capillary tube in a cartridge. (Photo by Aramide Taiwo).

Power Supply

Power supply provides an electric field across the capillary. This can be operated either in constant voltage, constant current or constant power mode. They can also be operated in normal or reverse polarity. Voltage up to 30 kV, currents up to 300 μ A and the power goes up to 6 W are used.

Capillary Electroseparation Modes

Capillary electrophoresis is versatile because of its different modes of separation. There are six modes listed below.

1. Capillary Zone Electrophoresis (CZE)
2. Micellar Electrokinetic Capillary Chromatography (MEKC)
3. Capillary Isoelectric Focusing (CIF)
4. Capillary Isotachopheresis (CITP)
5. Capillary Gel Electrophoresis (CGE)
6. Capillary Electrochromatography (CEC)

Table 2.1. Modes of capillary electroseparation and the basis of separation.

Mode of separation	Basis of separation
CZE	Free solution mobility
MEKC	Hydrophobic/Ionic interactions with micelle
CIEF	Isoelectric point
CITP	Moving boundaries
CGE	Based on size and charge
CEC	Two-phase distribution

MEKC Micellar Electrokinetic Capillary Chromatography

MEKC has been used in the separation of a wide variety of species (Terabe, 2004) which could be charged species or neutral species including amino acids, food, drugs, antiretroviral drugs, pesticides, etc. (Manuel, 2007). In order to perform a MEKC separation, a surfactant is added (Alvarez-Rivera et al., 2018) to the running buffer at a concentration is higher than the critical micellar concentration (CMC) (Hanran et al., 2010, Rizvi et al., 2011). Above this concentration, the micelles which are spherical structures with hydrophobic tails (Quirino et al., 2008) are formed. Due to the polar head groups, the micelles are charged, and they move electrophoretically (Hancu et al., 2013), therefore the aqueous phase and micellar phase make up the running buffer phase (Liu et al., 2003). A micelle consists of cluster of 40 to 100 surfactant molecules in which the hydrocarbon tail points inward while the negatively charged heads point outward as seen in the Fig. 2.7.

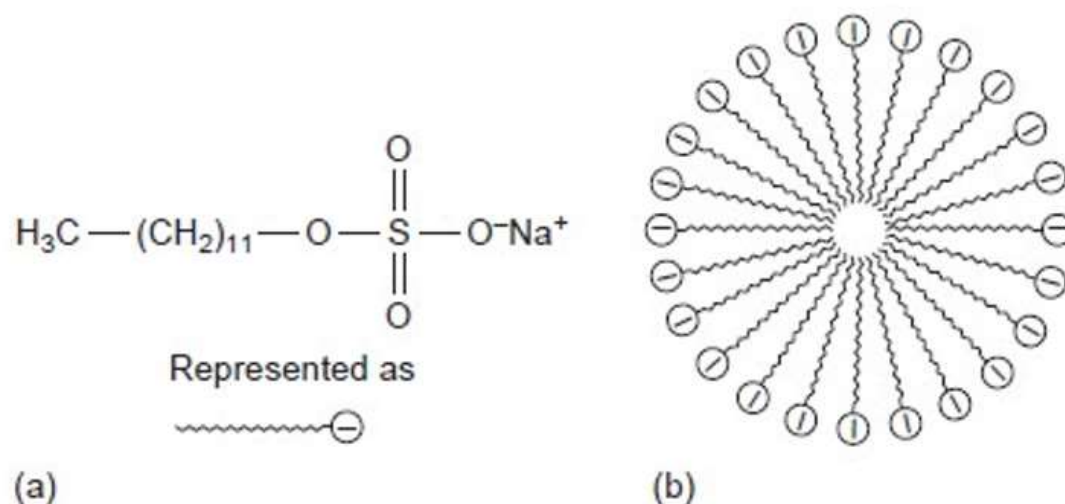

Fig 2.7. (a) Structure of sodium dodecylsulfate and (b) Structure of a micelle.

MEKC is advantageous over other CE electroseparation techniques because the separation of analytes can be obtained due to difference in electrophoretic mobilities and well as difference in solute partitioning (Rizvi et al., 2011), it also has the unique ability to separate ionic as well as neutral species especially organometallic compounds of which organoarsenicals found in the environmental samples fall under (Liu et al., 2003).

Addition of organic solvents such as acetonitrile and methanol to buffers increase the velocity of the micelles, however, their concentration should not exceed 25-30%, otherwise, the micellar structure may be broken down (Hancu et al., 2013). The problem with MEKC is that the parameters such as buffer concentration, buffer pH, temperature and voltage need to be optimized and this may be difficult (Fayez et al., 2016).

In MEKC, there is the capacity factor as it is in chromatography:

$$k = \frac{n_{mc}}{n_{aq}}$$

where n_{mc} and n_{aq} are the amount of analyte incorporated into the micelle and in the aqueous respectively. It can be calculated from the migration time of the analyte (t_R), of the EOF (t_0) and the micelle (t_{mc}):

$$k = \frac{t_R - t_0}{t_0 \left(1 - \frac{t_t}{t_{mc}}\right)}$$

when $k = 0$, the migration time of the analyte is equal to t_0 , which means analyte does not interact with the micelle; and when k is infinity, the migration time of the analyte is equal to t_{mc} which means analyte is totally incorporated in the micelle. The capacity factor in chromatography is what electrophoretic mobility is in electrophoretic process (Hancu, 2013).

Capillary Zone Electrophoresis (CZE)

Capillary zone electrophoresis is also known as free solution capillary electrophoresis. In this technique, ions are separated based on the mobility of ions (Beck and Engelhardt, 1992). It is the simplest form of capillary electrophoresis. The mechanism of separation is based on differences in charge-to-mass ratio (Perret, 2000). Capillary zone electrophoresis is a technique that has been successfully used for the separation of inorganic anions and cations, such as those typically separated by ion chromatography.

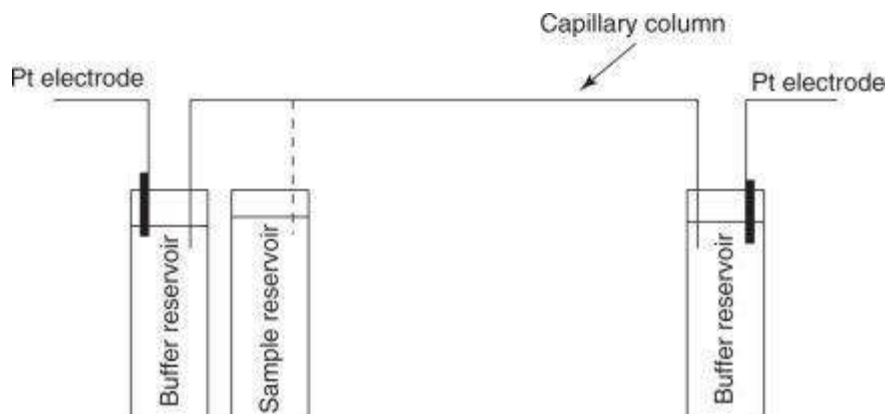

Fig. 2.8. Schematic representation of a capillary zone electrophoresis. (Weinberger, 2000).

The capillary tubing is immersed into two buffer-filled reservoirs. Through two platinum electrodes, high voltage is applied to the reservoirs. The sample which is stored in a separate reservoir (vial) is injected by hydrodynamic or electrokinetic impulse. The volume injected is usually very low, in the nanoliter range. The components of the sample are separated using 10

kV – 30 kV potential difference between the two ends of a 50 – 100 μm diameter capillary filled with a buffer solution, into discrete zones as shown below (Nagy and Vekey, 2008).

The fundamental parameter, electrophoretic mobility, μ_{ep} , can be approximated from Debye-Huckel-Henry theory:

$$\mu = \frac{q}{6\pi\eta r}$$

where q is the net charge, r is the Stokes radius, and η is the viscosity.

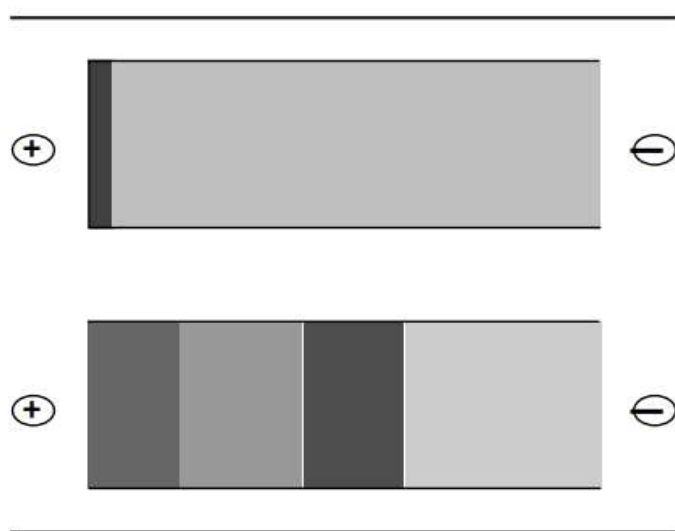

Fig. 2.9. Capillary Zone Electrophoresis (Beckman Coulter handbook of capillary electrophoresis, Coulter 2009).

Capillary Isoelectric Focusing (CIEF)

This mode of electrophoresis uses a principle similar to that of a gel, where analytes migrate within a stable pH gradient formed by carrier ampholytes under the control of an electric field (Smoluch et. al., 2006). Ampholytes are used to form pH gradient within the capillary and the target analytes are focused through the ampholyte medium (Otter, 2003) based on their isoelectric points (pI) while moving in the gel matrix where different charge variants are distinguished (Suba, 2015) into positive charges balance their negative charges (zero charge) (Schmitt, 1997).

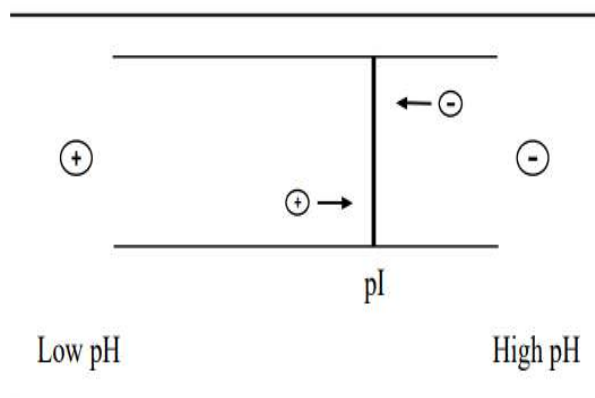

Fig. 2.10. Isoelectric Focusing (Beckman Coulter handbook of capillary electrophoresis, Coulter, 2003).

Capillary Electrochromatography (CEC) has its operation similar to liquid chromatography (Poole et al., 2000). Separation in CEC is done by electroosmotic flow driving the mobile phase through a stationary phase (Gerard, 2001). CEC is usually coupled with mass spectrometry because combining with UV detection results in poor detection (Simo et al., 2005, Huber et al., 2001).

Capillary Isotachopheresis (CITP)

In capillary isotachopheresis (CITP), a discontinuous buffer system is used based on the differences in electrophoretic mobility (Poole, 2003), also called displacement electrophoresis (Weinberger, 2000). In this technique, solutes are focused along the capillary based on their effective mobilities and the molar amount of the analytes affect the separation and separation time (Hirokawa, 2018). The resulting electrical field is not homogeneous across the capillary when voltage is applied (Vegvari, 2005). CITP can also be combined with MS detection for low level analytes but the mass spectra may turn out poor as CIPT concentrates the samples resulting in narrow bands, this process is solved by using a dual-column CITP-CZE (Cifuentes, 2005). It is highly useful for analysis of complex mixtures in solution e.g., solutions of inorganic ions. In the analysis of samples with complex matrices, CITP generates better results when combined with CZE where isotachopheresis serves as the preconcentration process and pre-separation step (Sadekcka et al., 2000). Fig. 2.11. illustrates six capillary electrophoresis separation methods based on their buffer type and mechanism.

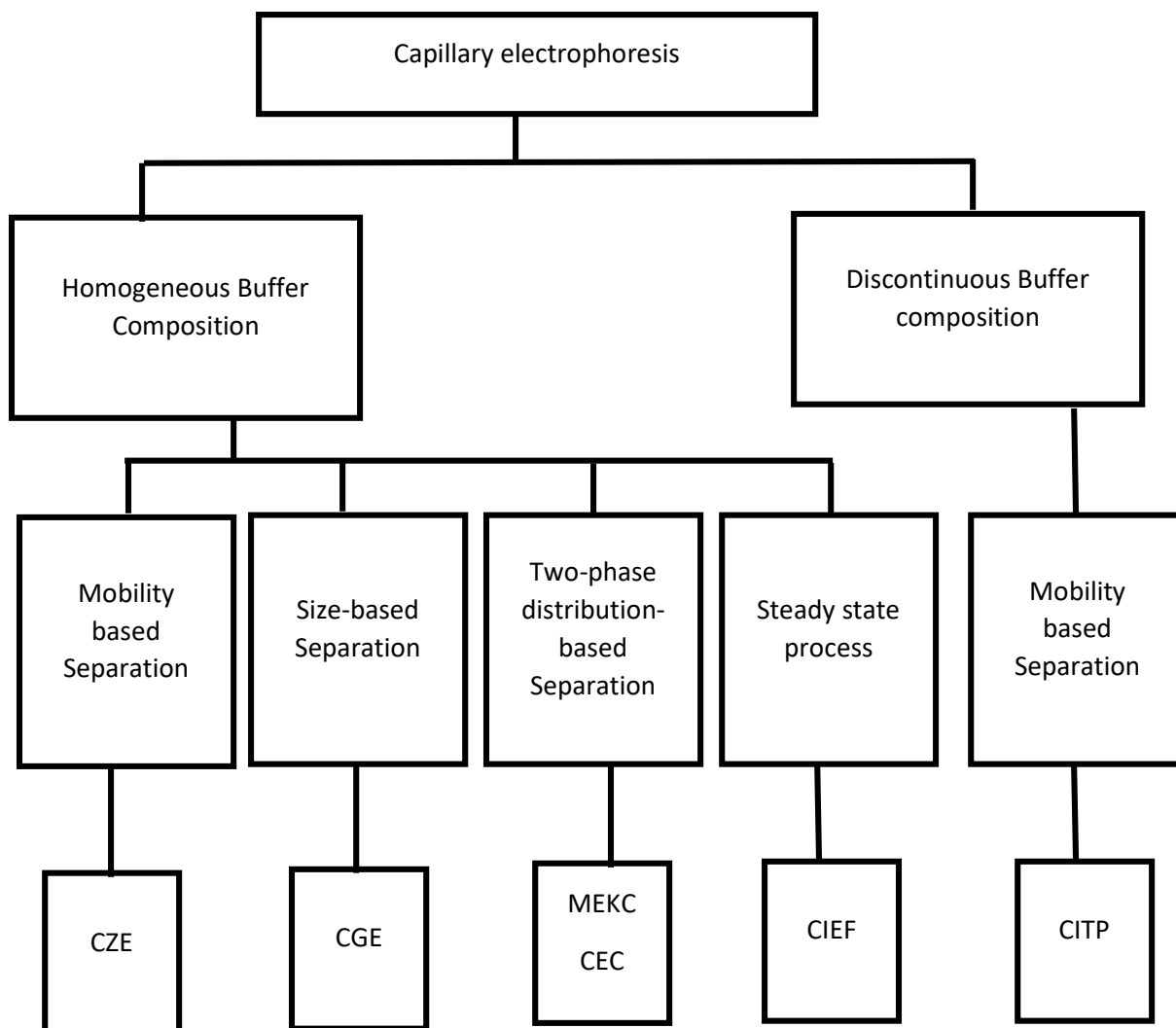

Fig 2.11. Classification of capillary electrophoresis separation methods based on buffer type and mechanism. CZE = capillary zone electrophoresis; CGE = capillary gel electrophoresis; MEKC = micellar electrokinetic chromatography; CEC = capillary electrochromatography; CIEF = capillary isoelectric focusing; and CITP = capillary isotachopheresis.

CE versus HPLC

Capillary electrophoresis is much more efficient than many other techniques as a result of its resolution. Van Deemter equation models the high-resolution separation technique such as chromatography and field-flow fractionation, and it relates the plate height, H , to the velocity, V_x , of the carrier gas or liquid along the separation axis, x .

$$H = A + \frac{B}{V_x} + CV_x$$

Multiple paths longitudinal diffusion Equilibration Time

Here, A, B and C are constants. A lower value of H, which is the height of plate, corresponds to a higher separation efficiency, V_x is the linear flow velocity. Hence, when the plate number is reduced, more theoretical plates (N) can be packed into a given length along the separation axis. In CE, the multiple-path (eddy diffusion) and the mass-transfer term are both eliminated because the separation is carried out in single phase of uniformly flowing carrier liquid. As a result, the only term remaining, is the longitudinal diffusion, $\frac{B}{V_x}$, which, under ideal conditions, is the fundamental source of band broadening. Typically, CE separation invokes 50,000 to 500,000 theoretical plates, and this magnitude is much higher than HPLC, making CE a more efficient method than HPLC (Xu, 1996).

Reproducibility

Non-reproducibility in CE in the analysis of samples can be seen in fluctuations in solute migration times especially when using non-selective detectors, such as UV-Vis absorbance monitors (Yang et al., 1996). Other factors that contribute to non-reproducibility in CE include sample matrix composition, injected sample volume (Schaepe et al., 2000). Integrity of capillary surface, rinsing procedures and age of capillary, these factors that affect the EOF of a system in turn affect the reproducibility (Shihabi et al., 1995). One way to improve reproducibility is washing capillary with NaOH after each injection or use of high ionic buffer. Replenishing the system with fresh buffer solutions before each analysis and replacing buffers solutions in vials every 5 - 6 injections also greatly improves reproducibility (Thomas et al., 1994).

Sensitivity

Sensitivity of CE can be improved by increasing the amount of analyte and this is not necessarily achieved by injecting more sample because doing that will result in deterioration

in quality of separation and possibly distortion of peak shape (Breadmore et al., 2001). On-line preconcentration is also a proven method of improving sensitivity in capillary electrophoresis by up to orders of magnitude (Swartz et al., 1993). Solid phase extraction (SPE) is a signal sensitivity enhancing technique for such online preconcentration (Almeda et al., 2008), this technique not only preconcentrates analytes, it also simultaneously removes problematic sample matrix that would otherwise be detrimental to the electrophoretic separation (Breadmore, 2009).

Sample Stacking is a method of concentrating samples. Sample stacking is one of the simplest preconcentration method where stacking is induced in the matrix and this is made possible because of the difference between the ionic strengths of the sample matrix and the separation buffer (Chien and Burgi, 1992). Large volumes of samples containing trace amounts of analytes are concentrated into short zone (Slampova et al., 2018). Capillary electrophoresis is much more sensitive than many other separation techniques, sample stacking is a great way to improve its sensitivity as this is a general limitation because the sample volume is always little. The concentration limit in capillary electrophoresis is usually in the order of 10^{-6} M which is why the sample stacking is necessary for optimum detection without loss in resolution and analysis time (Burgi and Chien, 1996). Sample stacking also improves the selectivity of analyses. Concentration adjustment by Kohlraush stacking works on the principle that stacking is performed by combining a long-plug of low-conductivity sample with a background electrolyte (BGE) of higher conductivity (Slampova et al., 2018). The sample is hydrodynamically injected into the run buffer, and the solutes disperse throughout the volume of the sample plug. When voltage is applied, the sample zone starts to migrate through the capillary, elutes in a zone that is slightly wider than, and proportional to the initial width of the sample plug (Baker, 1995). The stacking principle includes techniques using hydrodynamic injection, called large-volume sample stacking (LVSS) which involves the injection of large volumes of sample (Zhang et al., 2013) or field amplified sample stacking injection (FASI).

SPE is combined with LVSS for the analysis of organoarsenicals in this research.

pH-mediated sample stacking

One of the strategies to improve the sensitivity of capillary electrophoresis is sample stacking, however, due to some small volume of sample, achieving field-amplified stacking of analytes in high-ionic strength samples which does not involve sample pretreatment such as dilution step or extraction, the pH-mediated sample stacking technique is developed (Arnett et al., 2003). In this technique, background electrolyte (BGE) is made from the salt of a weak acid, then the sample with high ionic strength is injected electrokinetically into the capillary with reversal of EOF. This results in displacement of sample anions such as chloride and acetate ions (Zhao et al., 1999). For cationic sample analysis, same principle is applied but a strong acid plug (instead of strong base plug), which after electrokinetic injection, titrates the acetate acid region across which the cationic samples stack (Gillogly et al., 2005). A disadvantage of pH-mediated sample stacking is that the solutions take up a huge portion of the capillary and little room is left for separation (Zhao et al., 1999).

CHAPTER 3
MATERIALS AND METHODS

Instrumentation

The Beckman Coulter P/ACE MDQ capillary electrophoresis system (Beckman Coulter, Brea, CA, USA) equipped with Ultraviolet detector and interfaced with the 32-Karat software for data acquisition. An uncoated fused-silica capillary with 50 μm internal diameter and total length of 60 cm was used. The separation is done in fused silica capillary from Polymicro Technologies, AZ, USA. The 25 mm Nylon® 0.45 μm syringe filter was purchased from Canadian Life Science, Ontario, Canada. The pH meter used was Mettler Toledo FE20-FiveEasy™ from Greifensee Switzerland, purchased from USA.



Fig. 3.1. Picture of capillary electrophoresis system in Prof. Donkor's research laboratory.

CE analysis were performed on the P/ACE MDQ system which is mounted with a UV detector. Data was collected and processed with the 32 Karat 8.0 software. The analytes (roxarsone and nitarosone) were detected at 214 nm using direct absorbance, normal and reversed polarity and a separation voltage of 20 kV was applied for a total of 22 min. Separations were carried out using a 50 μm (I.D.) x 365 μm (O.D.) x 60 cm (L_T) bare-fused silica capillary (Polymicro

Technologies, Phoenix, AZ, USA) fixed in a cartridge. Temperature of the system was maintained at 25 °C by circulating a liquid fluorocarbon coolant system. The new capillary was built into the cartridge and conditioned by rinsing with 1 M NaOH (20 psi, 40 min), 0.1 M NaOH (20 psi, 20 min) and water (20 psi, 10 min). It was then flushed with buffer of 20 mM pH 10 (10 min, 20 psi). Sodium carbonate-sodium bicarbonate ($\text{NaHCO}_3\text{-Na}_2\text{CO}_3$).

The capillary was rinsed with 0.1 M NaOH (20 psi, 3 min), water (20 psi, 1 min) and with buffer (20 psi, 4 min) before injecting the sample with LVSS (15.0 psi, injection time 0.5 min, applied reverse potential 10 kV and time of reverse polarity 5 min). The capillary was filled with water and the ends immersed in vials of water when not in use.

Capillary Conditioning

The capillary is made of fused silica which is brittle. It is coated with polyimide to make it flexible. A window of 0.5 cm is exposed in order to allow light from lamp to pass through so components can be detected. This window is opened by burning that space 12 cm from the end, and char is cleaned off with methanol and wiped with Kimwipe. Conditioning enhances the electroosmotic flow (EOF) by deprotonating the silanol groups (SiOH) into silanoate ions (SiO^-). The capillary is rinsed with 1.0 M NaOH for 40 min and 0.1 M NaOH for 20 min and finally with 18 m Ω water and the waste from each vial is collected into an empty vial in the buffer outlet.

Samples

In this research, the water samples were collected from the poultry section of Sullindeo farms, Kamloops, BC. Sources included trough, well and river in and around the farm. The samples were refrigerated upon collection and filtered through 0.45 μm Nylon® syringe filters to remove solid particles, then analyzed using the developed CE method without further pre-treatment.

Study Site

Sullindeo farms is an urban farm located on the ALR, Westsyde, Kamloops, BC. Chicken broilers and turkey are grown on the farm and processed in government inspected facilities and ready for consumption. The aerial view of the farm site is shown in Fig. 3.2.

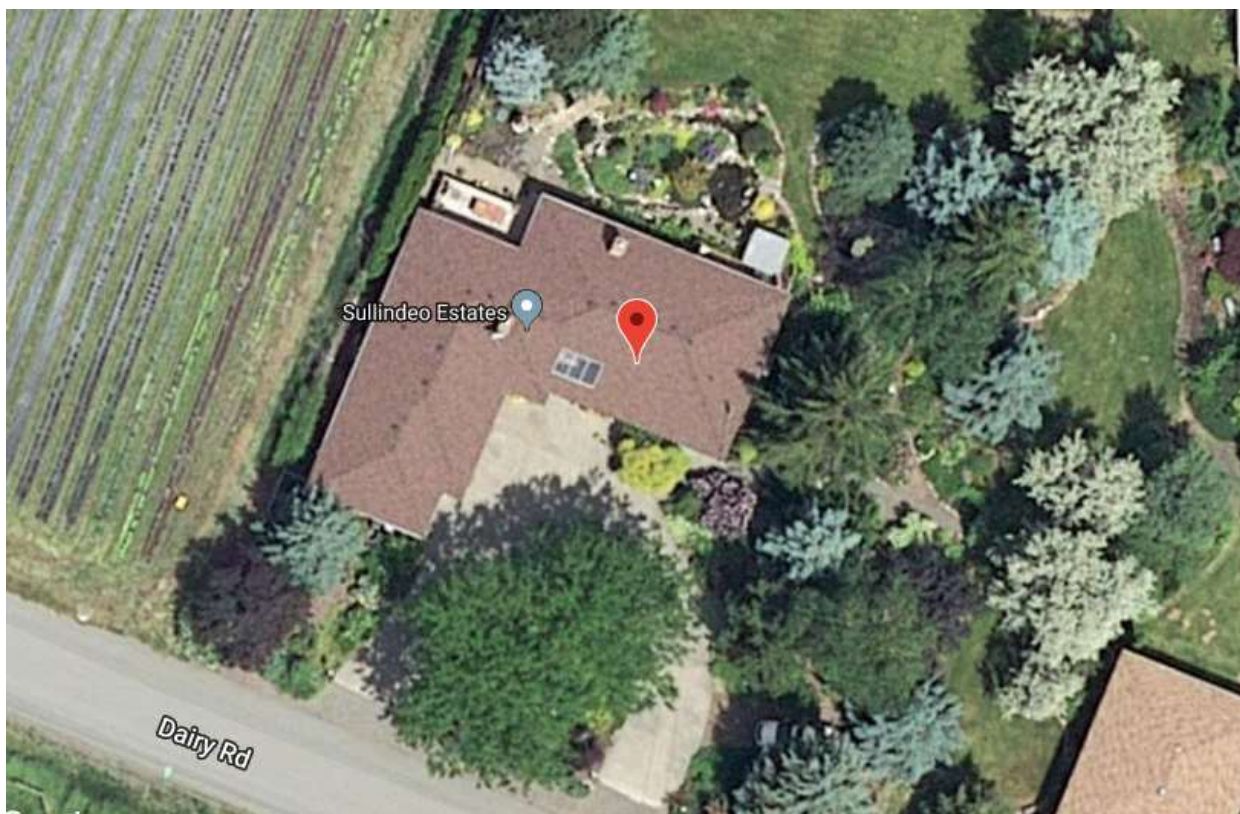

Fig. 3.2. Aerial view of field site in Kamloops, British Columbia, Canada.

The farm consists of mainly two wells and two tap locations including one at the entrance of the poultry range where the troughs are filled. The water sources (tap, well and trough) are directly from the river along dairy road. None of these samples are from the government treated water source. The field site is about 12 acres large with fences and gates added to keep the flocks from invading the poultry.

Calibration and analysis of samples

Nitarsonsone and roxarsone were purchased from Sigma Aldrich, Oakville, ON, Canada. Sodium phosphate was purchased from Sigma Aldrich. Sodium hydrogen carbonate and sodium carbonate were obtained from Sigma Aldrich.

Preparation of Solutions

- Standard Stock Solution Preparation

Nitarsonsone: A standard stock solution of 200 ppm was prepared by weighing 2.00 mg of nitarsonsone and dissolving in 18 MΩ water in 100 mL volumetric flask and diluting to volume. The stock solutions were all filtered with 0.45 μm Nylon® syringe filters and stored in the refrigerator. The stock solution was then diluted into different standard solutions with different concentrations of 150 ppm, 100 ppm, 50 ppm, 20 ppm, 10 ppm for the analysis.

Roxarsone: The same procedure as above for nitarsonsone was followed for preparing the stock solution and aliquots for standards.

Background Electrolyte (BGE) Preparation

Over the course of the research, three buffers were examined before the one with optimal results was adopted.

- Sodium tetraborate ($\text{Na}_2\text{B}_4\text{O}_7 \cdot 10\text{H}_2\text{O}$) solutions at 60 mM was prepared by dissolving 5.7206 g of the solid salt in 100 mL of 18 MΩ water and adjusting the pH using 0.2 M NaOH/HCl.
- Sodium phosphate solution of 60 mM concentration and pH 7.2 which is commercially prepared by Sigma Aldrich.
- Sodium carbonate-sodium bicarbonate ($\text{NaHCO}_3\text{-Na}_2\text{CO}_3$) solution of concentration 20 mM at pH 10.0. An 80 mL of 18 MΩ water in a beaker, 0.0779 g (of corresponding concentration of 0.092 M) of sodium bicarbonate NaHCO_3 together with 0.1142g of anhydrous sodium carbonate, Na_2CO_3 (equivalent to 0.0108 M). The solution containing both salts is stirred thoroughly and made up to 100 mL in a volumetric flask. The pH of this solution is confirmed to be 10.0 using the Mettler Toledo pH meter. Other concentrations, 30 mM, 40 mM of the ($\text{NaHCO}_3\text{-Na}_2\text{CO}_3$) at pH 9.0, 9.5 and 10.0 were prepared and investigated for optimum results.

The following chart shows the preparation procedures for the buffer - 20 mM NaHCO_3 - Na_2CO_3 at pH 10.

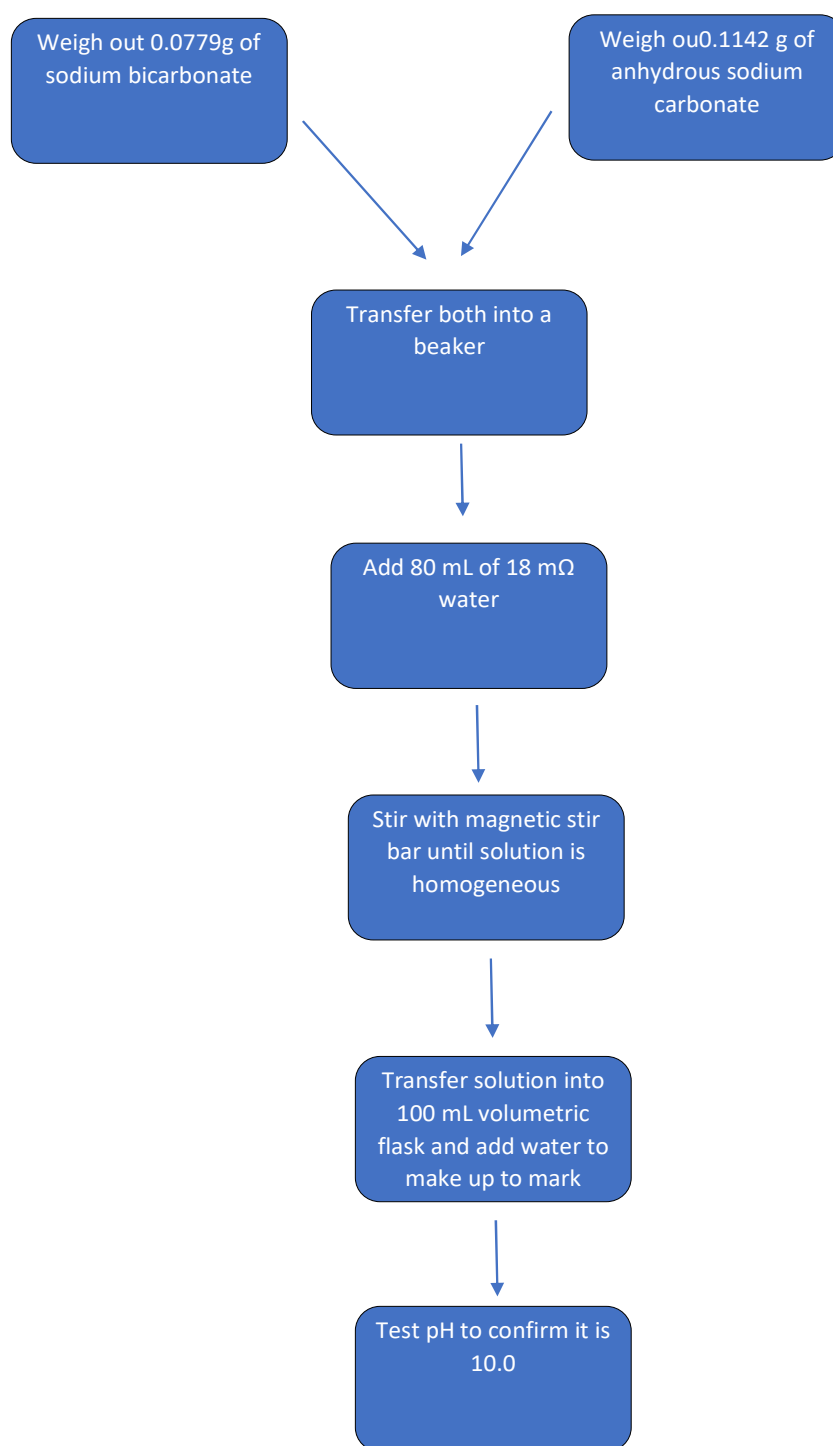

Fig. 3.3. Flowchart for preparation of sodium carbonate- sodium bicarbonate buffer

Preconcentration

Preconcentration is done to improve the limits of detection for CE which is constrained by dimensions of capillary. Small volume of capillary limits volume of sample injected into CE. Analyte bands are then compressed within the capillary, increasing the volume of sample that can be injected without reduction of the CE efficiency (Osbourn et al., 2000).

Solid Phase Extraction (SPE)

Solid phase extraction as discussed earlier is essential for extracting a group of analytes from a matrix of the sample. The *Supelco* solid phase extraction vacuum manifold system model has twelve ports and each one can be used for single extraction. The cartridge works as a miniature chromatography column. It has to be activated and conditioned before extraction and elution of sample. Cartridge may already be packed, otherwise, it is manually packed by filling the empty cartridge with the underlying frits, then filling with 400 mg C18 and topping with the top frits at vertical meniscus. The pair of frits are used for filtering to avoid solvent elution from the cartridge. Appropriate amount of solvent, i.e., methanol, must be used. In each case, at the end of the elution, the frit is removed by vacuum and soaked in acetonitrile, sonicated for 10 min and cartridge can be washed separately. Three different cartridges were used.

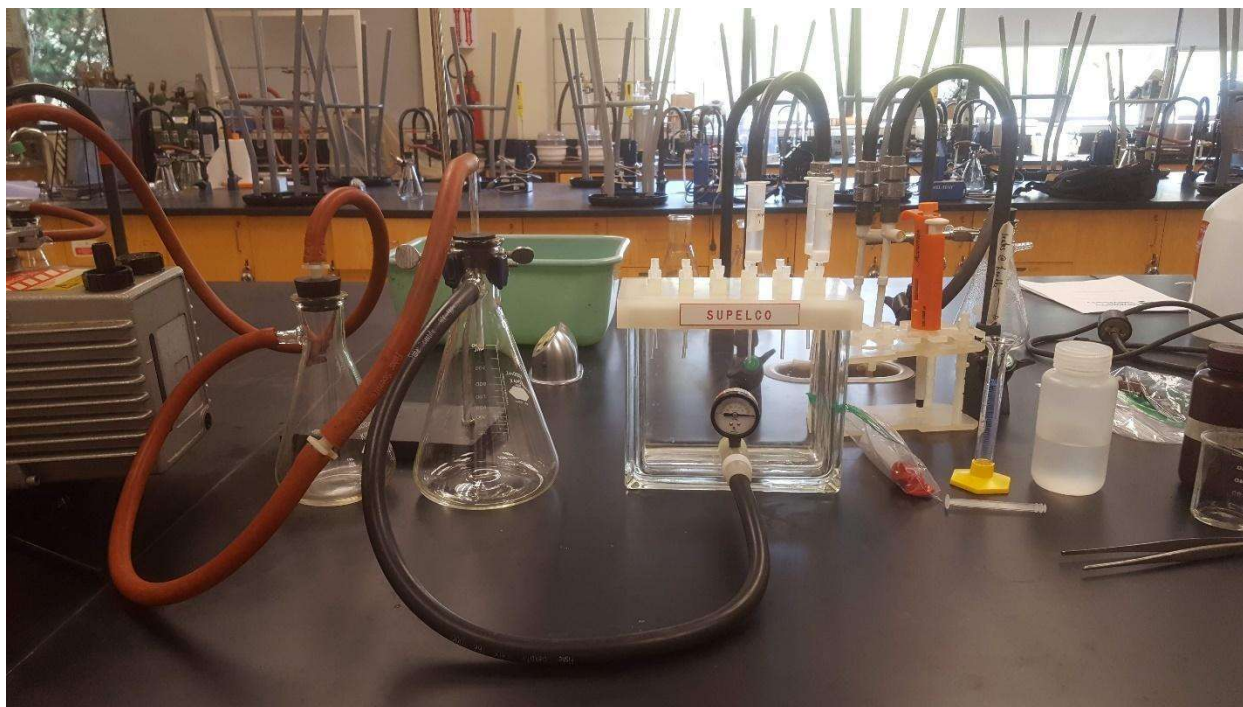

Fig. 3.4. A set up of solid phase extraction

Types of SPE Cartridges Tested

Polymeric Strong Cation Exchange

The polymeric strong cation exchange cartridge was purchased from Phenomenex, Torrance, CA, USA. This method is most appropriate for roxarsone because of the charge around the ring.

Conditioning the cartridge:

- To prepare the cartridge, 1 mL of methanol was passed through the cartridge. 1 mL of acidified water (distilled water spiked with 1.0 M HCl) was also passed through the cartridge in order to activate the sorbent.
- Both nitarsone and roxarsone 100 ppm standards concentrated 50 times.

$$C_{\text{sample}} = 10 \text{ ppm} / 50 = 0.2 \text{ ppm} = 20 \text{ ppb}$$

$$V_{\text{aliquot}} = 50 \text{ ppm (sample)} \times 0.2 \text{ ppm} / 100 \text{ ppm standard} = 0.1 \text{ mL standard.}$$

From the above, 0.1 mL of each of 100 ppm nitarsone and roxarsone standard is spiked into 50 mL 18 m Ω water. Then 50 mL of the spiked solutions were loaded by passing all 50 mL slowly through the cartridge while the vacuum enhances the extraction.

- For clean up, 1 mL of HCl of 0.1 M was passed through the cartridge to wash it. Valve is opened to allow cartridge to dry for 5 min then 1 mL of methanol is used to recover the analyte by passing it through the concentrate and collecting slowly into a buffer vial. The methanol recovers the neutral version of the organoarsenicals. A 1 mL aliquot of methanol containing 5% NH₄OH used to recover the basic form of roxarsone.

C18 cartridge (Reversed phase)

The C18 cartridge is commercially cheaper than the other cartridges. It was also purchased from Phenomenex, Torrance, CA, USA. This cartridge is most appropriate for neutrally charged ions. When conditioning, addition of methanol causes the C-18 chain to collapse

- To start with, 5 mL of methanol is passed through the C18 cartridge and 5 mL of acidified water at pH 2.0 is also passed through the cartridge. Then 50 mL of nitarsone and roxarsone-spiked water is passed slowly through the cartridge. The valve is opened, and cartridge is allowed to dry for 5 min with the aid of the vacuum. Roxarsone is less retained by C18. Therefore, only 1 mL of methanol is passed through the cartridge and extract collected in a buffer vial.

Polymeric Anion Exchange

The polymeric anion exchange cartridge was purchased from Phenomenex, Torrance, CA, USA. Roxarsone changes charges and at pH 6-7, it acts as an anion and must be extracted as such. The cartridge used is Strata TM-X-AW-33 μ m Polymeric weak anion.

- The packed cartridge is conditioned with 1 mL methanol, 1 mL 18 M Ω (at pH 6 -7) and 1-mL of 25 mM ammonium acetate C₂H₇NO₂ at pH 6.5.
- Then 1 mL of ethanol is passed through the cartridge. The elution is faster with the polymeric anion pack.

Electrophoretic Procedure for Standards and Sample Analysis

Roxarsone and nitarosone do not absorb in the ultraviolet range (UV range) which is above 200 nm (Sun et al. 2002). For this reason, the analyte will be detected indirectly since indirect UV detection is more appropriate for analysis of organoarsenicals by CE. The capillary is conditioned at the start of analysis each day. This is done by rinsing at 20 psi with 1 M NaOH, 0.1 M NaOH for 20 min each and 18 M Ω for 10 min as well with the BGE for 40 min. A capillary of inner diameter 50 μ m was used both for conditioning and separation of analytes. The conditioning of the capillary was done daily and for separate analysis. The separation was performed for 18 min at 20 kV at normal polarity and at a constant temperature of 25 °C. The roxarsone standards of concentrations ranging from 20 ppm, 50 ppm, 100 ppm, 150 ppm and 200 ppm were prepared for optimization. Standard nitarosone solutions of similar concentrations were also prepared in the optimization of the method. Samples were injected at 15 s interval and a pressure of 0.5 psi. All three buffers listed earlier at different concentrations and pH were employed and varied in the analysis. The wavelength was changed between 214 nm and 280 nm to find the more suitable condition. The applied voltage and the injection pressure were also varied for optimal condition. The migration time of the peaks were observed to be between 9 min and 12 min, so the separation time was reduced. In order to identify the peak of roxarsone and nitarosone individually, a matrix of both was run in the same sequence with the standards. A calibration curve was prepared from the results from the analysis of the standards with the peak areas of the analytes (roxarsone and nitarosone) on the *y*-axis and the corresponding concentrations in ppm on *x*-axis. The equation of the line generated from the regression can be used in deducing the corresponding concentration of the peak area of the analyte in sample. The samples were prepared by mixing specific volumes of sample with 18 M Ω water. The volumes added were 50 μ L, 100 μ L, 200 μ L sample and made up to 500 μ L in the plastic sample vial. All standards and samples were vortexed for 30 s to ensure homogeneity. Replicates of the standards as well as the samples were analyzed.

Standards that have been preconcentrated by SPE were also analyzed. Standards were diluted with water and the concentrations analyzed were 250 ppb – 2 ppm. The separation time was 25 min and the separation was carried out both in reverse and normal polarity modes.

After optimization, the samples from the poultry were optimized as well. The optimized conditions obtained are shown in Table 3.1.

Optimized CE conditions

Table 3.1. Optimized CE conditions for analysis of roxarsone and nitarsonsone.

UV Detector absorbance	280 nm
Capillary inner diameter	50 μm
Capillary total length	60 cm
Sodium carbonate-sodium bicarbonate concentration	20 mM
Buffer pH	10.0
Separation time	18 min
Voltage	20 kV
Temperature	20 $^{\circ}\text{C}$
Polarity	Normal

Large Volume Sample Stacking

LVSS Procedure

The capillary is rinsed with 0.1 M NaOH at 20.0 psi pressure for 3 min. Then rinsed with water at 20.0 psi for 1.00 min and further rinsed with the buffer (BGE) at 15.0 psi pressure for 4.0 min and lastly rinsed with sample at 15.0 psi for 0.50 min. The separation is done at 10.0 kV for 5 min in reverse polarity. The process is autozeroed and further separation by voltage is done at 20.0 kV for 20.0 min on normal polarity. The details of the method used for analysis is shown in Table 3.2.

Table 3.2. Large volume sample stacking method for separation of nitarsonic and roxarsonic.

Time (min)	Event	Value	Duration (min)	Inlet Vial	Outlet Vial	Summary	
	Rinse- Pressure	20.0 psi	3.00	BI:A2	BO:A1	forward	0.1 M NaOH
	Rinse- Pressure	20.0 psi	1.00	BI:A1	BO:A1	Forward	Water
	Rinse- Pressure	20.0 psi	4.00	BI:B1	BO:A1	Forward	Buffer
	Rinse- Pressure	15.0 psi	0.50	BI:E1	BO:A1	Forward	Sample
0.00	Separate- Voltage	10.0 kV	5.00	BI:D1	BO:D1	0.17 min ramp, reverse polarity	
0.00	Autozero						
5.00	Separate - Voltage	20.0 kV	20.0	BI:D1	BO:D1	0.17 min ramp, normal polarity	Buffer analysis

CHAPTER 4
METHOD VALIDATION

Method Validation

Method validation means confirmation, provided there are pieces of evidence, that the requirements of a certain method which is intended for application has been met. It is defined as the process of defining an analytical requirement and confirming that the method being considered has the capacities of performance that are consistent with what the application requires (Bernal, 2014). In order to develop an analytical method using capillary electrophoresis to detect and quantify arsenic species in water, the conditions of the experimental conditions must be optimized, and this optimization is done by changing the factors that influence the technique to provide steady and reproducible results.

Factors that need to be adjusted for optimization for the capillary electrophoresis technique include the inner diameter of the capillary, the voltage applied, the current, the wavelength of the detector, the buffer type, its concentration and pH and the constituents of the background electrolyte.

Results of Optimization

Analysis by normal CE

Buffer Type: Many buffers were investigated using concentrations 5 ppm – 100 ppm of both roxarsone and nitarosone. The 25 mM phosphate (Na_2HPO_4) solutions with a pH 7.0 was examined. The standards solutions of roxarsone and nitarosone were prepared in the following concentrations for calibration curve: 5 ppm, 10 ppm, 20 ppm, 50 ppm, 100 ppm. Analysis with this BGE produced certain peaks in electropherograms at a detection wavelength of 214 nm. Although the analysis resulted in fine peaks for nitarosone, irregular peaks were seen for the suspected roxarsone in simultaneous analysis.

Following this, the buffer 60 mM sodium tetraborate ($\text{Na}_2\text{B}_4\text{O}_7 \cdot 10\text{H}_2\text{O}$) solution with pH range of 9.0 – 10.0 was tested. The standards solutions of roxarsone and nitarosone were prepared in the following concentrations for calibration curve: 5 ppm, 10 ppm, 20 ppm, 50 ppm, 100 ppm. Peaks were observed for both nitarosone and roxarsone however, the increase in peak area with increase in concentration of standard was inconsistent.

Analysis of roxarsone and nitarsonsone standards with sodium carbonate-bicarbonate as BGE was also carried out at varying concentration and pH. Concentrations between 20 mM and 60 mM and pH at 9.0, 9.5, 10.0, 10.5 and 11.0 were prepared and standards analyzed with each for optimal results. Of these conditions, 20 mM sodium carbonate- sodium bicarbonate at pH 10.0 produced optimal results for simultaneous analysis of nitarsonsone and roxarsone in a matrix. The standards solutions of roxarsone and nitarsonsone were prepared in the following concentrations for calibration curve: 20 ppm, 50 ppm, 100 ppm, 150 ppm, 200 ppm. Resolution of the peaks was good. The electropherogram is shown in Fig. 4.1.

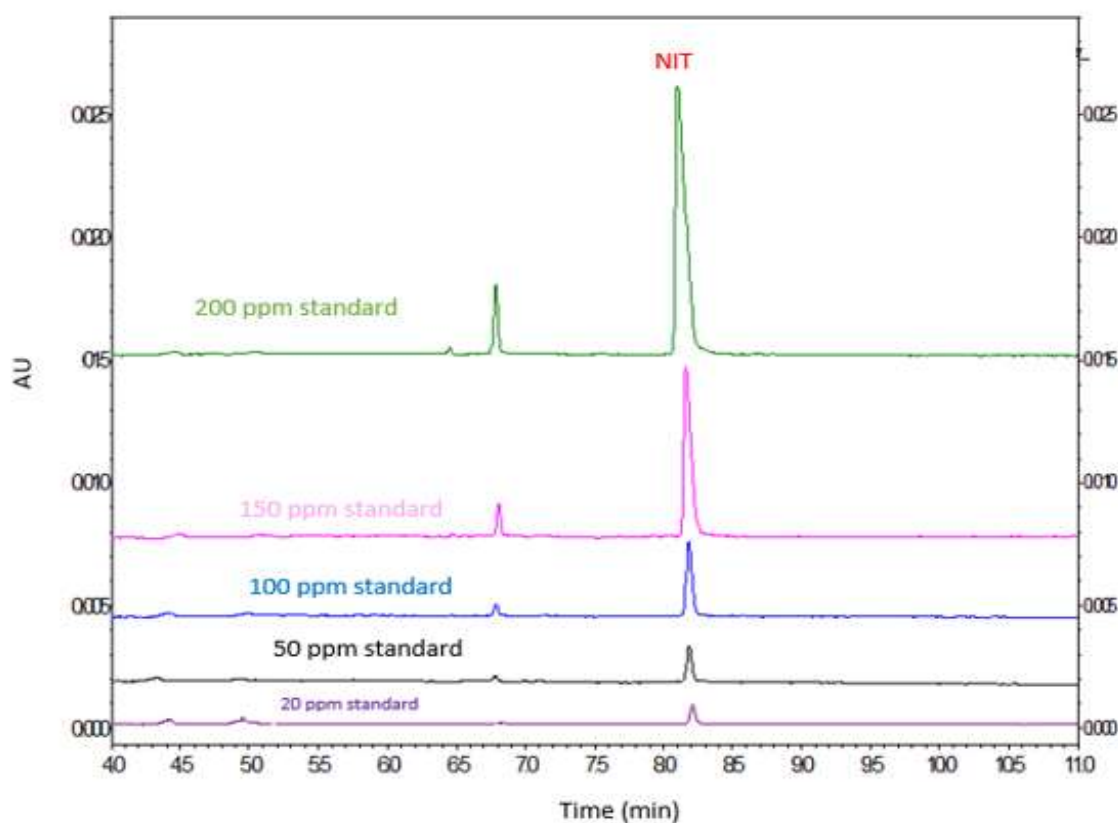

Fig. 4.1. Electropherogram of nitarsonsone standards 20 ppm, 50 ppm, 100 ppm 150 ppm, 200 ppm. (BGE: 20 mM sodium carbonate-sodium bicarbonate, pH 10.0, wavelength 214 nm). The target analyte peaks emerged at ~ 8.60 - 8.80 min.

Table 4.1. Calibration data (concentration and peak area) for nitarsonsone standards.

Standard nitarsonsone solutions		
Concentration (ppm)	Peak area	Migration time (t_m)
20	11122	8.671
50	28447	8.642
100	54582	8.692
150	81796	8.767
200	104796	8.863

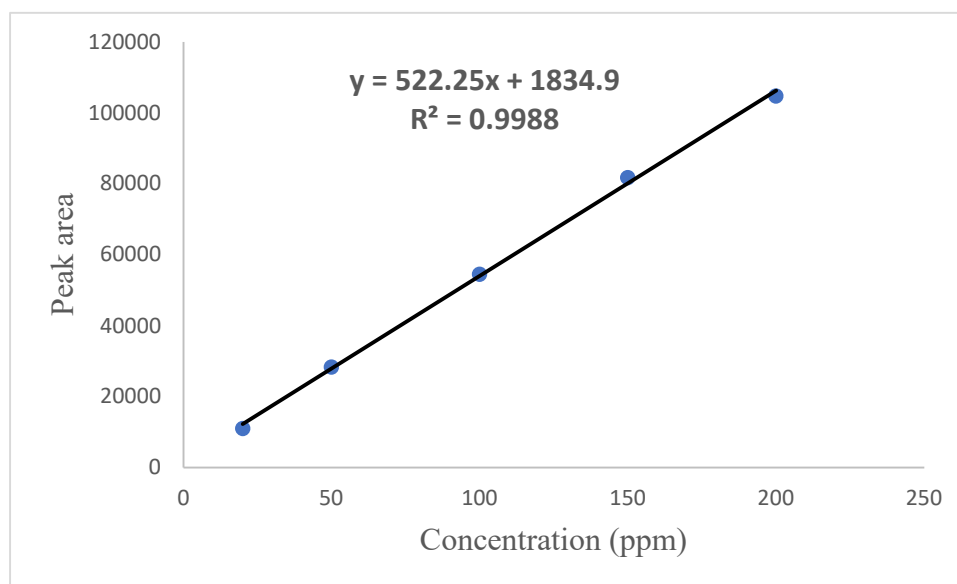

Fig. 4.2. Calibration curve of peak area of nitarsonsone versus nitarsonsone concentration.

Following this analysis, peak areas for samples were found to be within 85-150, which on extrapolation yielded unreasonable concentrations in the negatives, hence the LVSS method was incorporated for enhanced signals.

Analysis by LVSS

Using the optimized conditions, the final calibration curve was derived from the incorporation of large volume sample stacking with CE. The lowest concentration in calibration for the normal CE was 5 ppm, with LVSS, the lowest concentration in calibration is now 500 ppb. The concentrations of standards prepared was 500 ppb, 1 ppm, 2 ppm, 5 ppm, 10 ppm and a linear calibration curve was obtained. For nitarsone, the line equation was $y = 20037x - 3208.9$ and $R^2 = 0.9984$.

The electropherograms, calibration tables and calibration curves of nitarsone are illustrated respectively in Fig.4.3. and Fig.4.4.

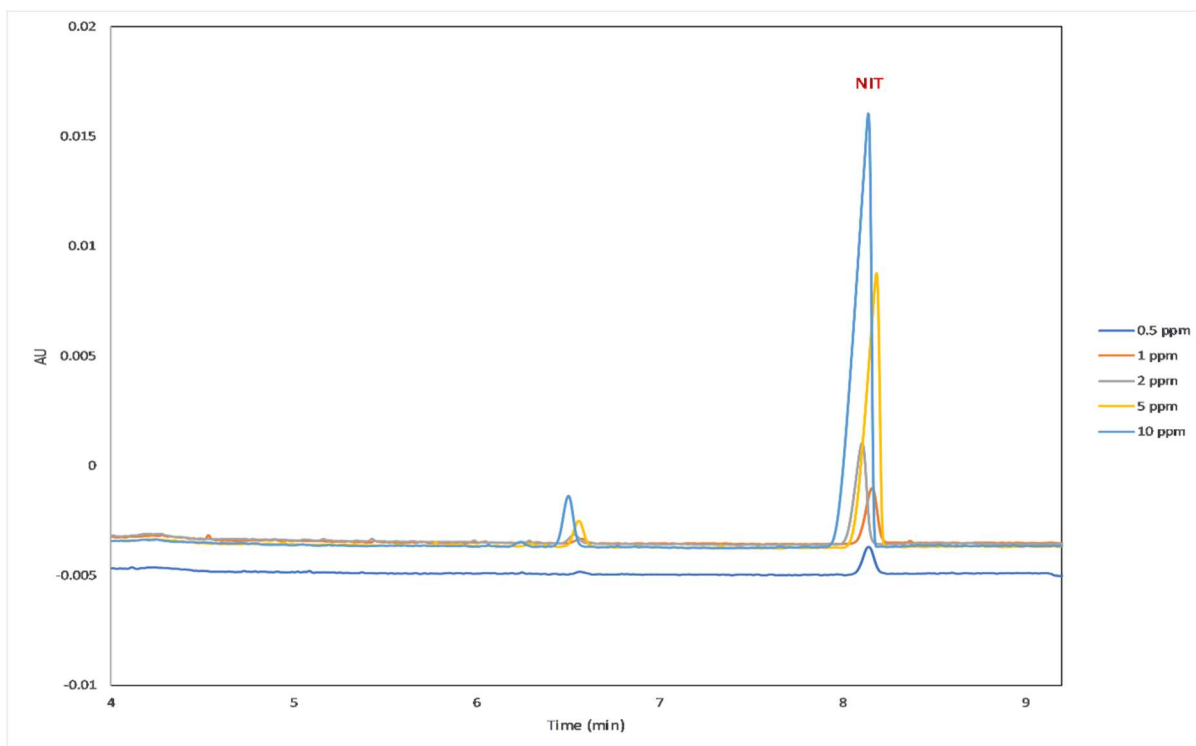

Fig. 4.3. Electropherogram of standards of nitarsone (concentrations: 0.5 ppm, 1.0 ppm, 2.0 ppm, 5.0 ppm, 10.0 ppm; BGE: 20 mM sodium carbonate - sodium bicarbonate, pH 10.0, wavelength 214 nm).

An unknown metabolite is seen to emerge at ~6.50 min, this metabolite is observed for more electropherograms in this research. The peak is probably a metabolite of nitarsone.

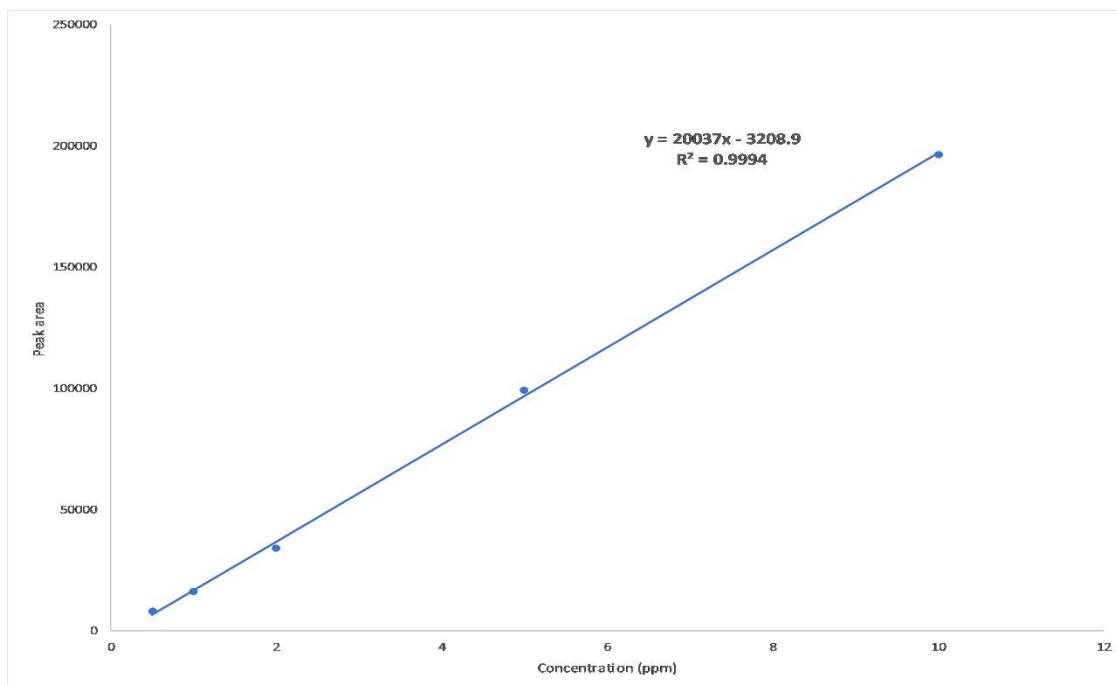

Fig. 4.4. Calibration curve of peak area of nitarsone versus nitarsone concentration.

Electropherograms of roxarsone and calibration curve for standards of concentration 0.5 ppm, 1.0 ppm, 2.0 pp, 5.0 ppm, 10.0 ppm are shown in Fig. 4.5. and 4.6.

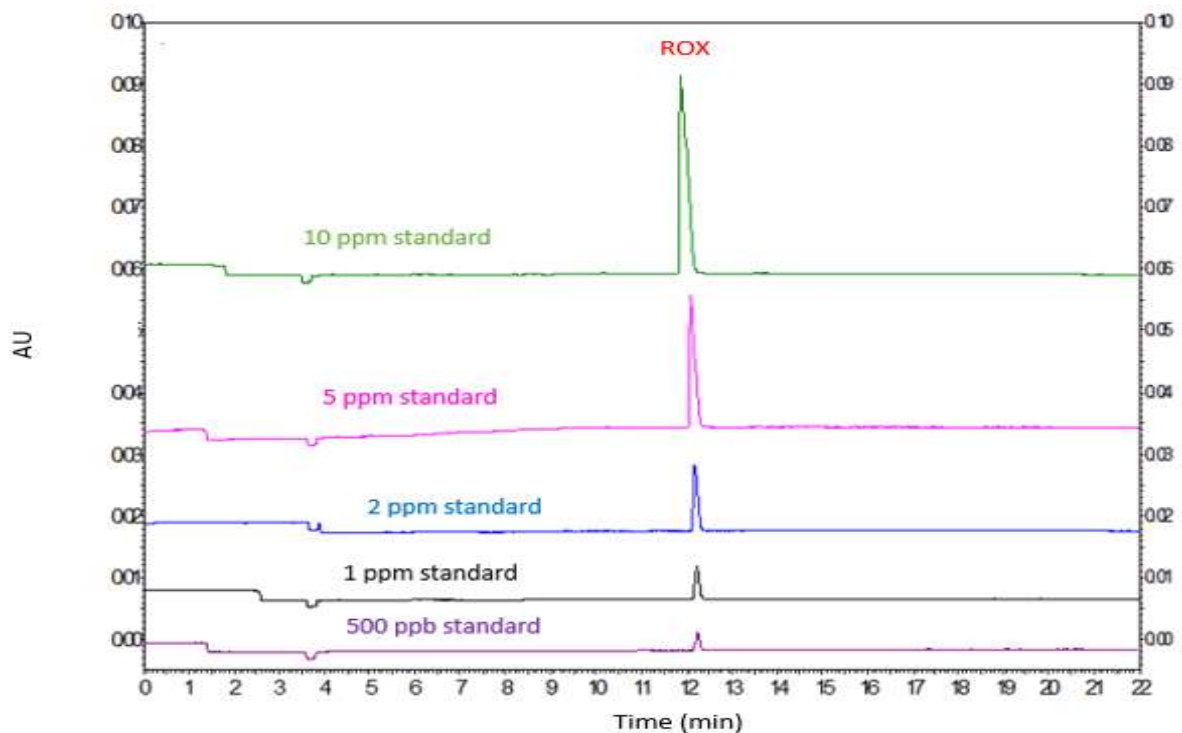

Fig. 4.5. Electropherogram of roxarsone standards of concentrations 500 ppb, 1 ppm, 2 ppm, 5 ppm and 10 ppm. (BGE - 20 mM sodium carbonate-sodium bicarbonate, pH 10.0, wavelength 214 nm, migration time ~ 12.2 min).

Table 4.2. Calibration data (concentration and peak area) for roxarsone standards.

Standard roxarsone solutions		
Concentration (ppm)	Peak area	Migration time (t_m)
0.5	15415	12.279
1.0	30184	12.225
2.0	65099	12.142
5.0	174558	12.088
10.0	359855	11.983

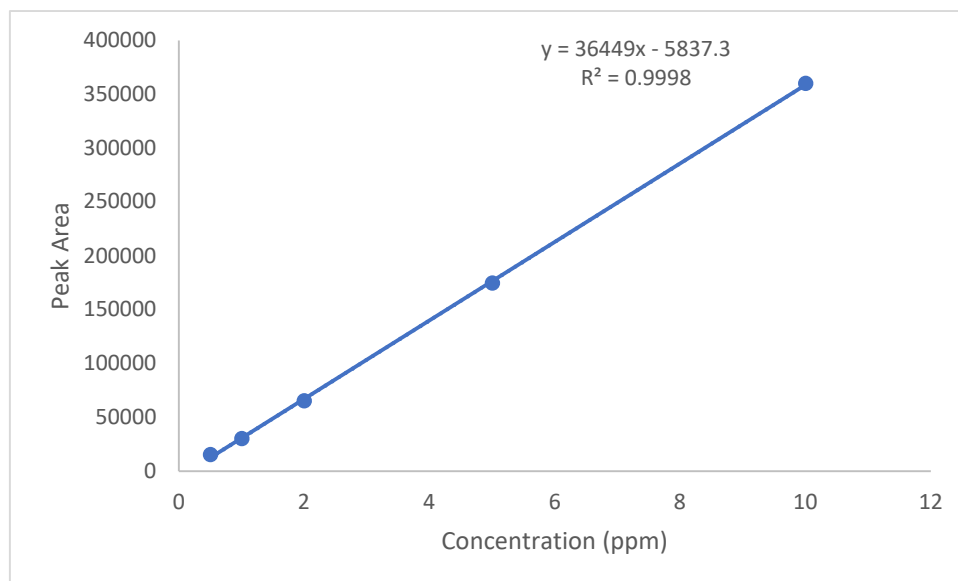

Fig. 4.6. Calibration curve of peak area of roxarsone versus roxarsone concentration.

Analysis by LVSS and SPE

Solid phase extraction analysis was further combined with LVSS in order to achieve lower calibration ranges. The calibration range for both nitarsone and roxarsone for this analysis was 50 ppb, 70 ppb, 90 ppb, 100 ppb, 150 ppb. However, peaks were not obtained for all points therefore a calibration curve could not be achieved. The electropherogram is shown in Appendix A1.

Percent Recovery Studies

Percent recovery shows how much of the original substance recovered at the end of analysis. It is represented in percent of the obtained concentration by starting amount.

$$\% \text{ Recovery} = \frac{\text{spiked (exp)}}{\text{Spiked (true)}} \times 100 \%$$

Spiked (true) = spiked concentration

Spiked (exp) = Spiked Concentration – Unspiked concentration

Recovery Results

The recovery of nitarsons and roxarsone was determined at low (1 ppm) and high concentration (10 ppm) by comparing the peak area of analyte in the samples with peak area of unspiked analyte.

One representative each of samples from the two well sources well, two tap sources and trough were analyzed for matrix effect. Once the electropherogram was retrieved, peaks were assigned by electrophoretic mobility and confirmed by spiking corresponding standards into the sample. Five-point calibration curves of peak vs. concentration of analytes were plotted for quantification using standard solutions. Table 4.3 and Table 4.4 show a summarized percent recovery results of nitarsons for the first and second set of samples, respectively, while Table 4.5 and Table 4.6. show the percent recovery results of roxarsone for the first and second set of samples, respectively.

Percent recovery for nitarsons in both first and second set of samples was between 93.8 % and 112.3 % while the percent recovery for roxarsone for bot first and second sets were between the range 84.2 % and 112.3 %. It is not strange that the percent recovery for both analytes exceed 100%, this is because of interfering unknowns which increase the signal of the target analytes.

Table 4.3. Percent recovery of nitarsone results for five samples of the first set by CE with LVSS.

The calibration equation: $y = 101280x + 13214$ $R^2 = 0.989$

Sample Name	Spiked concentration (ppm)	Recovered Concentration (ppm)	% Recovery
Tap water 1A	1.0	0.95	94.7%
	2.0	2.10	105.0%
	5.0	5.48	109.6%
	10.0	10.88	108.8%
Tap water 2A	1.0	0.92	92.0%
	2.0	1.77	88.5%
	5.0	5.62	112.3%
	10.0	10.66	106.6%
Well water 1A	1.0	0.96	96.1%
	2.0	2.08	104.0%
	5.0	5.39	107.9%
	10.0	10.36	103.6%
Well water 2A	1.0	1.06	105.6%
	2.0	1.93	96.5%
	5.0	5.14	102.8%
	10.0	9.78	97.8%
Trough water A	1.0	0.93	93.5%
	2.0	2.16	108.0%
	5.0	4.86	97.2%
	10.0	9.71	97.1%

Table 4.4. Percent recovery of nitarsone results for five samples of second set.

Sample Name	Spiked concentration (ppm)	Recovered Concentration (ppm)	% Recovery
Tap water 1B	1.0	1.0	99.0%
	2.0	2.1	106.5%
	5.0	5.1	102.2%
	10.0	11.1	110.6%
Tap water 2B	1.0	1.0	96.0%
	2.0	1.9	94.5%
	5.0	5.3	106.4%
	10.0	11.0	109.7%
Well water 1B	1.0	1.0	103.6%
	2.0	2.2	108.0%
	5.0	4.7	93.8%
	10.0	10.2	102.3%
Well water 2B	1.0	1.1	111.0%
	2.0	2.2	112.0%
	5.0	4.8	95.8%
	10.0	10.7	107.2%
Trough water B	1.0	1.0	103.6%
	2.0	2.2	108.2%
	5.0	5.0	100.0%
	10.0	9.7	96.9%

Table 4.5. Results of percent recovery for nitarsone in first set of samples.

Sample Name	Spiked concentration (ppm)	Recovered Concentration (ppm)	% Recovery
Tap water 1A	1.0	0.93	92.5%
	2.0	1.68	84.2%
	5.0	4.37	87.3%
	10.0	9.65	96.5%
Tap water 2A	1.0	0.96	95.6%
	2.0	2.14	106.8%
	5.0	5.05	100.9%
	10.0	9.68	96.8%
Well water 1A	1.0	1.04	103.6%
	2.0	1.90	94.9%
	5.0	4.69	93.8%
	10.0	9.99	99.9%
Well water 2A	1.0	1.10	110.4%
	2.0	2.07	103.3%
	5.0	4.92	98.5%
	10.0	10.66	106.6%
Trough water 1A	1.0	0.89	89.4%
	2.0	2.01	100.6%
	5.0	5.36	107.2%
	10.0	9.68	96.8%

Table 4.6. Results of percent recovery of nitarsonsone in second set of samples.

Calibration equation: $y = 18413x - 10913$ $R^2 = 0.9958$

Sample Name	Spiked concentration (ppm)	Recovered Concentration (ppm)	% Recovery
Tap water 1B	1.0	0.86	86.0%
	2.0	1.97	98.6%
	5.0	4.69	93.8%
	10.0	10.04	100.4%
Tap water 2B	1.0	1.12	112.3%
	2.0	2.15	107.7%
	5.0	4.99	99.7%
	10.0	10.18	101.8%
Well water 1B	1.0	1.26	125.5%
	2.0	1.89	94.6%
	5.0	5.37	107.4%
	10.0	10.36	103.6%
Well water 2B	1.0	1.06	105.6%
	2.0	1.90	94.8%
	5.0	4.88	97.7%
	10.0	10.22	102.2%
Trough water B	1.0	0.99	98.5%
	2.0	2.17	108.4%
	5.0	5.15	103.0%
	10.0	10.03	100.3%

Interday and Intraday Precision Studies (%RSD)

This study validates the reproducibility of the method developed on capillary electrophoresis. The intraday study was done by analyzing standards of roxarsone and nitarsonsone three times a day while the interday precision analysis was carried out on the standards on three different days. The results of the analysis are presented in relative standard (% RSD) of peak area (<5%) and migration time (t_m) (<2%). The %RSD values < 10 indicate that the method is precise and reproducible.

Table 4.7 - First Day of interday precision studies for roxarsone on CE.

Day 1	Concentration (ppm)	Peak area (n=3)			Mean	SD	% RSD
	0.5	53486	49729	53729	513240	2242	4.3
	5.0	515445	532300	519985	522577	8721	1.7
	10.0	970790	967547	1017736	985358	28087	2.9
	Concentration (ppm)	Migration time (n=3) min			Mean	SD	%RSD
	0.5	13.68	13.64	13.73	13.68	0.05	0.4
	5.0	13.39	13.41	13.50	13.50	0.06	0.4
	10.0	12.53	12.66	12.82	12.67	0.14	1.2

Table 4.8. Second day of interday precision studies of roxarsone on CE.

Day 2	Concentration (ppm)	Peak area (n=3)			Mean	SD	% RSD
	0.5	56891	60431	59900	59074	1909	3.2
	5.0	600087	582754	590923	591255	8671	1.5
	10.0	1032956	1119047	1107521	1086508	46734	4.3
	Concentration (ppm)	Migration time (n=3) min			Mean	SD	%RSD
	0.5	13.89	14.056	14.29	14.08	0.17	1.2
	5.0	14.95	14.60	14.60	14.70	0.18	1.2
	10.0	14.30	14.40	14.32	14.33	0.04	0.3

Table 4.9. Third day of interday precision studies for roxarsone on CE.

Day 3	Concentration (ppm)	Peak area (n=3)			Mean	SD	% RSD
	0.5	52247	49258	50547	50684	1499	3.0
	5.0	500356	501489	501265	501037	600	0.1
	10.0	965148	987412	986324	979628	12551	1.3
	Concentration (ppm)	Migration time (n=3) min			Mean	SD	%RSD
	0.5	14.146	14.362	14.208	14.239	0.11	0.8
	1.0	14.078	14.183	14.225	14.162	0.08	0.5
	10.0	14.124	14.155	14.132	14.137	0.02	0.1

Table 4.10. First day interday precision studies for nitarosone on CE.

Day 1	Concentration (ppm)	Peak area (n=3)			Mean	SD	% RSD
	0.5	20179	20663	20396	20413	242	1.2
	5.0	232110	210673	221503	221429	10718	4.8
	10.0	472568	472459	474431	472673	472708	0.1
	Concentration (ppm)	Migration time (n=3) min			Mean	SD	%RSD
	0.5	10.40	10.375	10.210	10.33	0.10	1.0
	1.0	10.81	10.698	10.873	10.79	0.08	0.8
	10.0	10.81	10.829	10.804	10.82	0.01	0.1

Table 4.11 Second day interday precision studies for nitarsone on CE.

Day 2	Concentration (ppm)	Peak area (n=3)			Mean	SD	% RSD
	0.5	21954	20608	22279	21613.67	723	3.4
	5.0	232163	221904	222996	225687.67	4600	2.0
	10.0	470037	471175	471242	471065.33	810	0.2
Day 2	Concentration (ppm)	Migration time (n=3) min			Mean	SD	%RSD
	0.5	8.196	8.125	8.167	8.162	0.03	0.4
	1.0	8.204	8.200	8.198	8.200	0.00	0.0
	10.0	8.162	8.162	8.142	8.155	0.01	0.1

Table 4.12. Third day interday precision studies for nitarsone on CE.

Day 3	Concentration (ppm)	Peak area (n=3)			Mean	SD	% RSD
	0.5	23767	24075	23742	23861	151	0.6
	5.0	243325	234246	238538	238703	3708	1.6
	10.0	471863	468508	473683	470451	3366	0.7
Day 3	Concentration (ppm)	Migration time (n=3) min			Mean	SD	%RSD
	0.5	8.350	8.404	8.463	8.406	0.06	0.6
	1.0	8.233	8.271	8.396	8.300	0.07	0.8
	10.0	8.229	8.325	8.329	8.294	0.05	0.6

Limit of Detection (LOD) and Limit of Quantification (LOQ)

Limit of detection is the lowest quantity of a substance that can be distinguished from the absence of that substance i.e., a blank value, with stated confidence level which is generally 99% (MacDougall et al., 1980). Limit of detection, although many times confused with, is not the same as sensitivity. It is the smallest amount or concentration of analyte in the test sample that can be distinguished from zero, reliably from an analytical procedure. At this point, detection is confidently feasible (Armbuster, 2008). According to Needleman and Romberg, “limit of detection is the ability to measure nothing” (Needleman and Romberg, 1990). The detection limit is estimated from the mean of the blank, the standard deviation of the blank as well as other confidence factors. The LOD was calculated based on the response of standard deviation of the signal-to-noise ratio (S/N) and the slope obtained. LOD is the concentration that gives a response with S/N ratio of 3 while LOQ is calculated as the concentration giving the response with signal-to-noise ratio of 10. The values for both LOD and LOQ for roxarsone were 449 ppb and 1.36 ppm, respectively, while the LOD and LOQ values for nitarsonsone were found to be 149 ppb and 452 ppb, respectively. The R^2 values of roxarsone and nitarsonsone are 0.9889 and 0.9988, respectively, and this proves very good linearity for the calibration curve.

Table 4.13. LOQ and LOD of roxarsone and nitarsonsone by CE with LVSS method.

	LOQ (ppb)	LOD (ppb)	Calibration Equation	R^2
Roxarsone	1364	449	$y = 101280x + 13214$	0.9889
Nitarsonsone	452	149	$y = 4737x - 3978.4$	0.9988

Matrix Effect

The matrix effect of the analyte signal is controlled by the standard addition method which is also known as the spiking method. Known amounts of stock solutions are spiked into the samples to enhance the signal of the desired analyte. This method is time-consuming therefore, few samples were selected for this analysis in order to save time.

Five measurements were carried out per sample and five vials were prepared to analyze each sample. A constant volume of sample (500 μL) was added to each vial. Then a series of increasing volume of stock solutions of nitarsone and roxarsone were added to these sample vials respectively except the first vial which was made to contain only the sample. Each vial contained 200 μL of sample and were spiked with 0, 10, 20, 50, 100, 200 μL of 100 ppm nitarsone and roxarsone. These vials were diluted with 18 M Ω water to 1000 μL . A standard addition plot was obtained by plotting the concentration of spiked roxarsone and nitarsone on the x-axis and the corresponding peak areas on the y-axis. Concentrations of unknown samples were determined by extrapolating to the x-axis. The y-intercept where $y = 0$, gives the concentration of the unknown as demonstrated in Fig. 4.7. The results obtained from the standard addition analysis are shown in Appendix B.

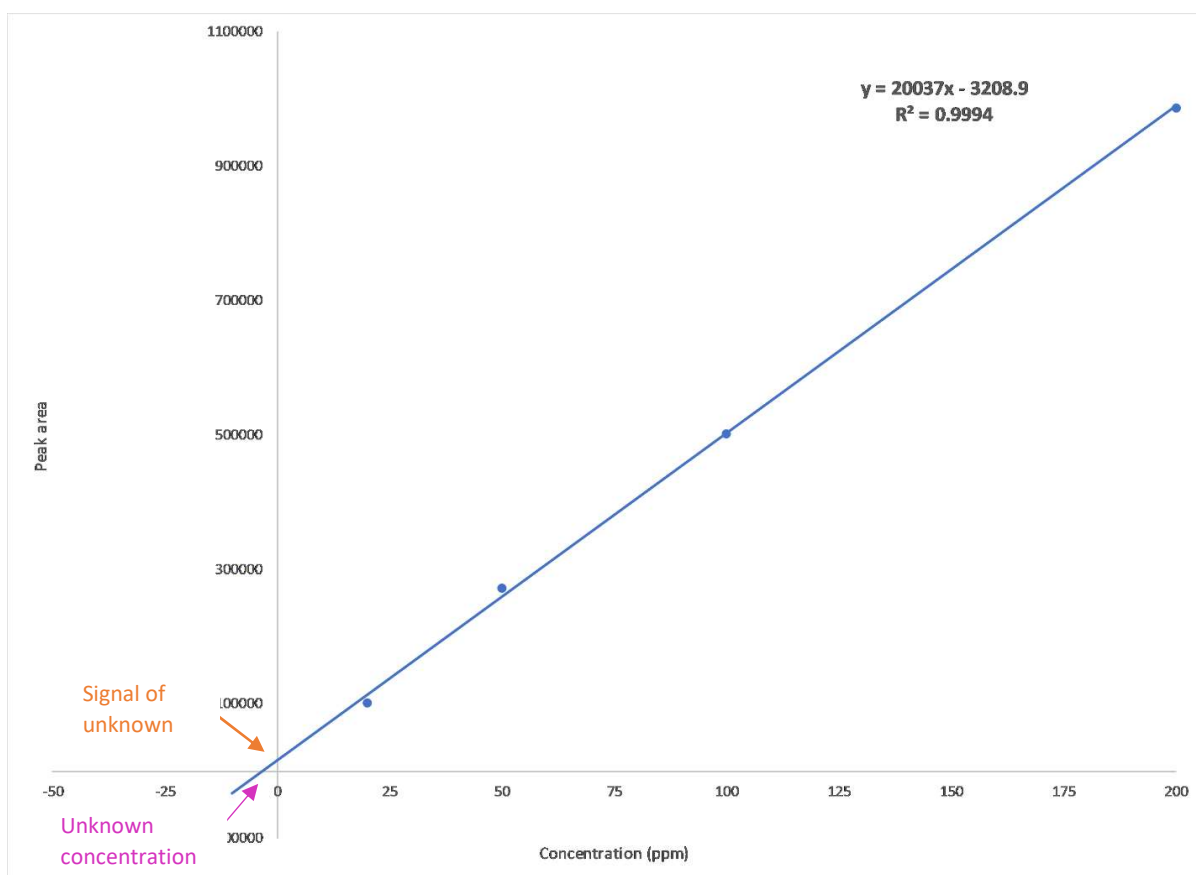

Fig. 4.7. Roxarsone concentration versus the peak area of roxarsone from the standard addition method (BGE - 20 mM sodium carbonate-sodium bicarbonate, pH 10.0, wavelength 214 nm).

Analysis of Farm Water Samples

Capillary electrophoresis method for determination of roxarsone and nitarsonsone in farm water samples was validated in order to ensure that the results obtained by the method is accurate. In preparation for analysis, all 10 samples were filtered to remove solid impurities. The analysis was able to detect roxarsone and nitarsonsone simultaneously in solutions. The identity was confirmed by migration time and with spiking approach the peak areas increased with standard addition. Figs. 4.8 and 4.9 show the results obtained for the farm water samples.

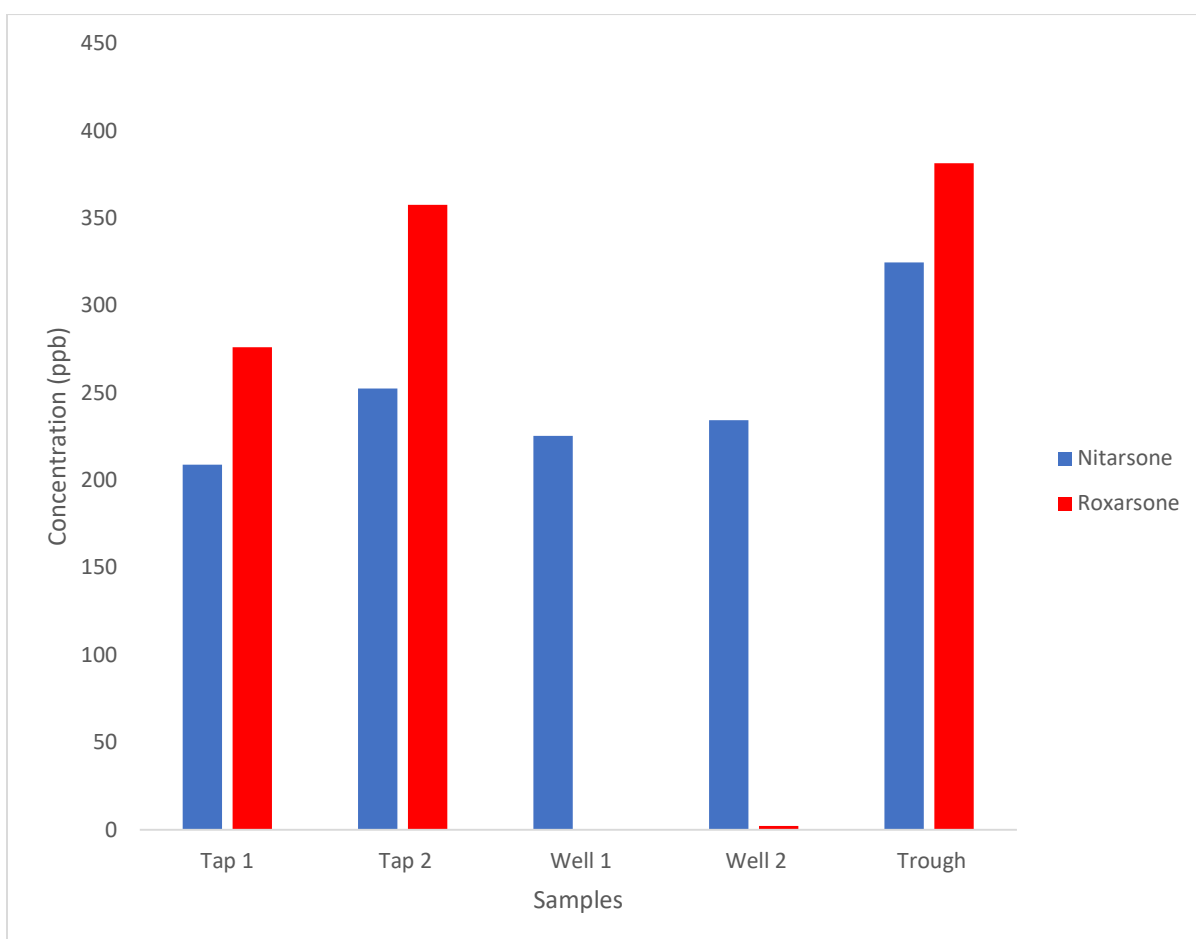

Fig 4.8. Nitarsonsone and roxarsone concentrations of farm waters from Summer sampling.

From Fig. 4.8, there appears to be higher concentration of roxarsone than nitarsonsone in tap and trough water samples. However, roxarsone was present in the least concentration in well water samples.

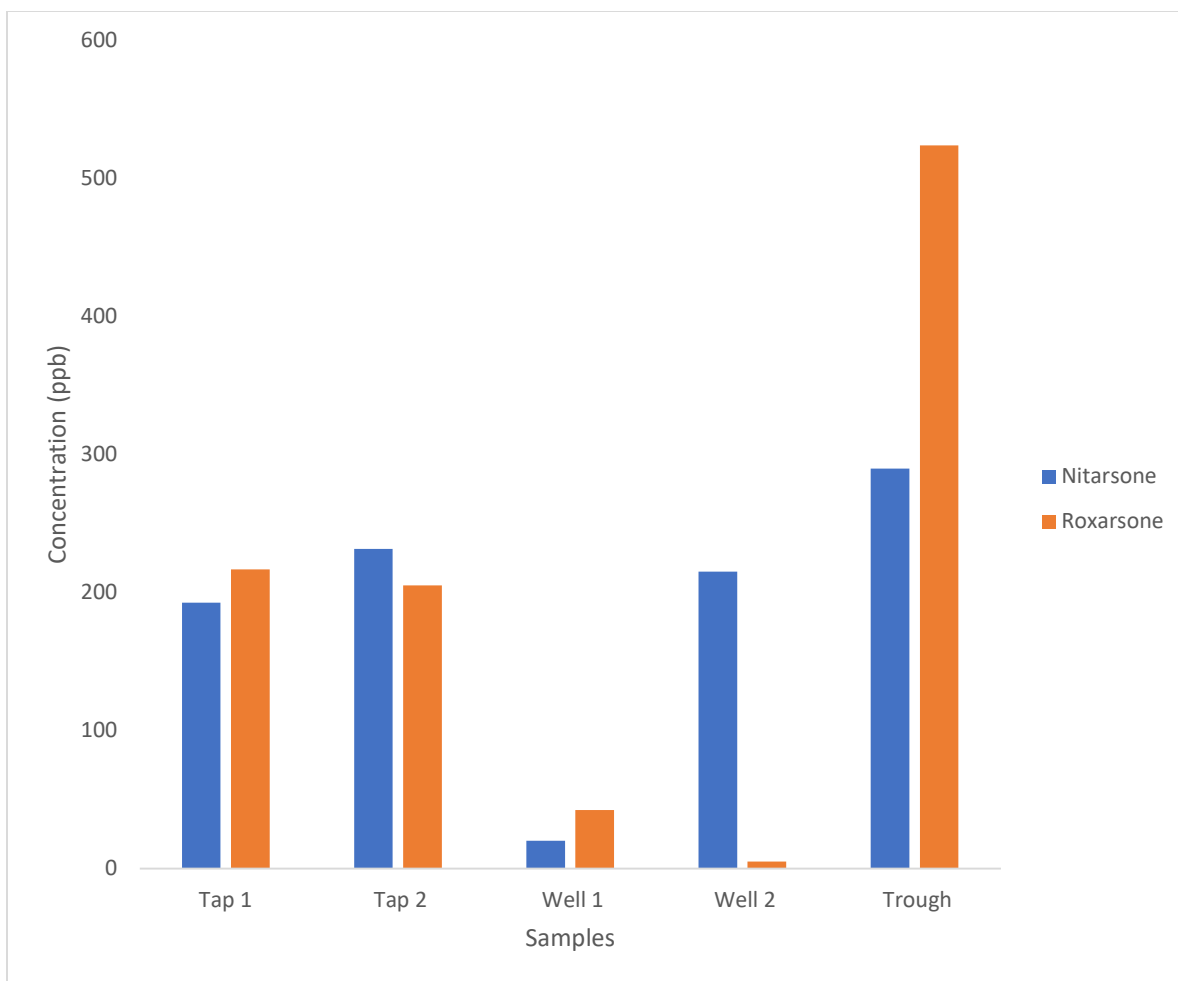

Fig. 4.9. Nitarsonsone and roxarsone concentrations of farm waters from Fall sampling.

From Fig. 4.9, a similar trend with the summer sample results is observed. Roxarsone is present in higher concentrations in tap and trough samples, however, nitarsonsone is detected in higher concentration in the well water samples.

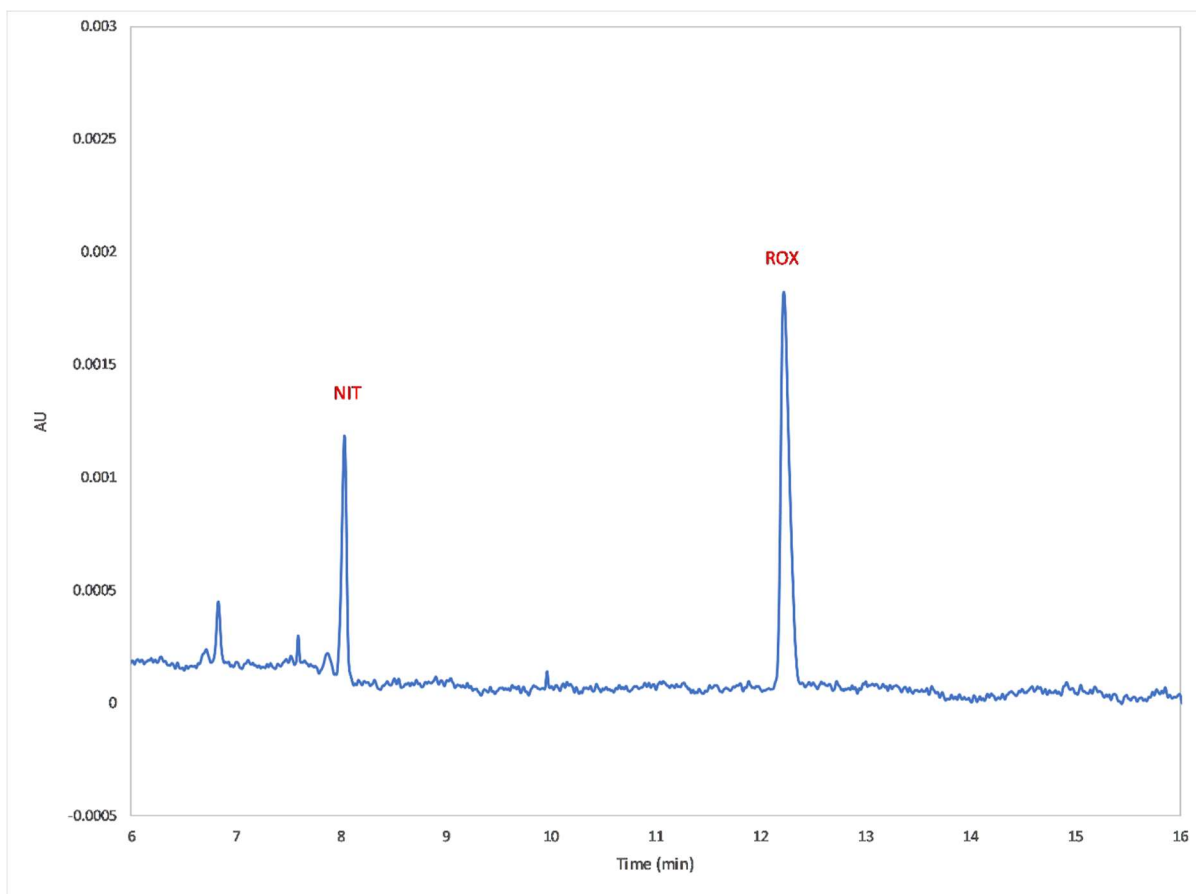

Fig. 4.10. Electropherogram for tap water 1A (BGE - 20 mM sodium carbonate-sodium bicarbonate, pH 10.0, wavelength 214 nm). Target peaks of roxarsone and nitarsone both emerging at their expected migration time were observed in this sample.

The electropherogram of simultaneous detection of roxarsone and nitarsone has a good baseline resolution. The peaks of roxarsone and nitarsone are sharp and the migration time for each one is distinct from the other, it can be inferred that this gap in migration time is probably due to the difference in sizes of nitarsone and roxarsone. Although their structures are similar, roxarsone has one phenol group more than nitarsone therefore, nitarsone, which is lighter will migrate faster than roxarsone.

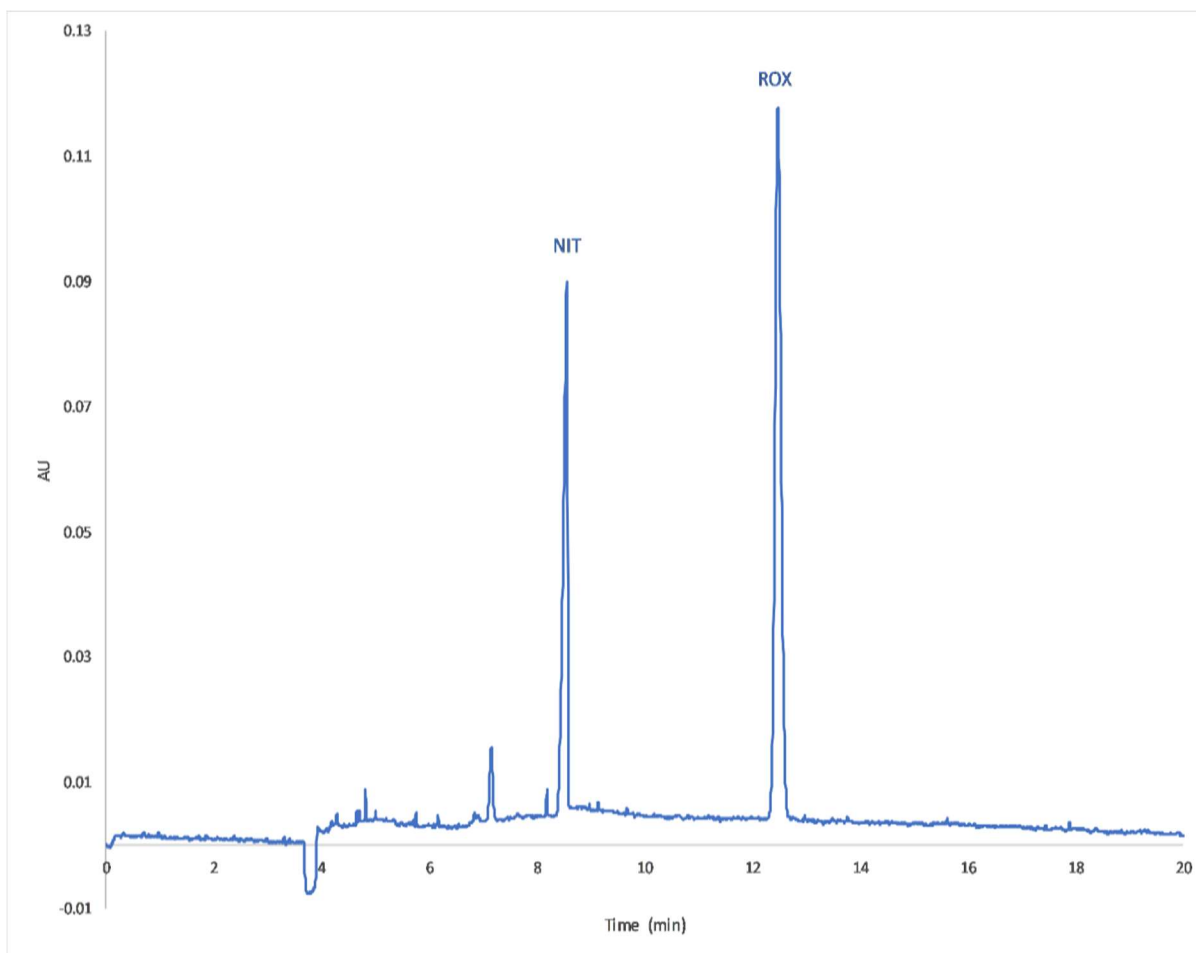

Fig. 4.11. Electropherogram for tap water 2A (BGE-20 mM sodium carbonate-sodium bicarbonate, pH 10.0, wavelength 214 nm). Target peaks of roxarsone and nitarsone both emerging at their expected migration time were observed in this sample.

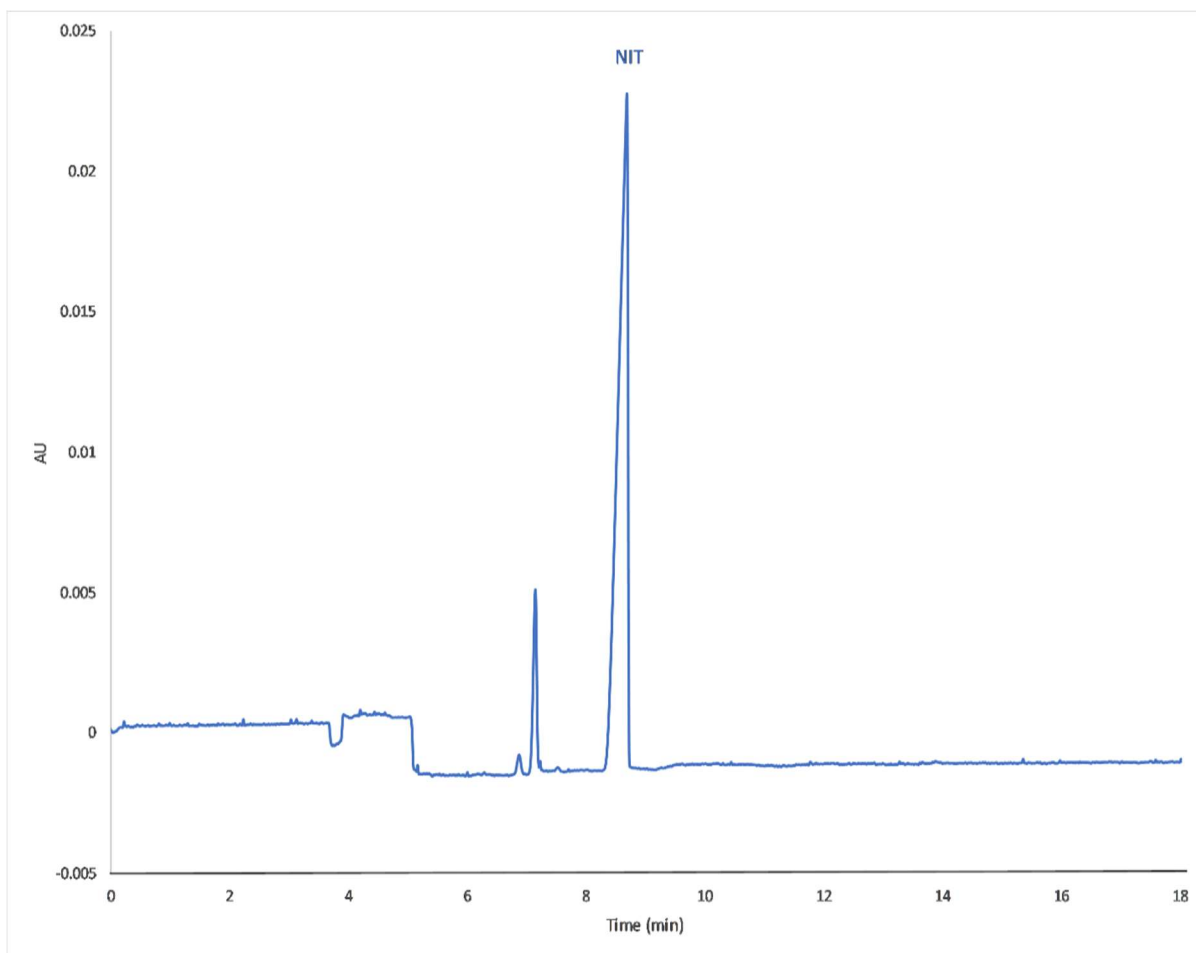

Fig. 4.12. Electropherogram for well water 1A (BGE - 20 mM sodium carbonate-sodium bicarbonate, pH 10.0, wavelength 214 nm). Only peak for nitarsone emerged at its migration time for this sample.

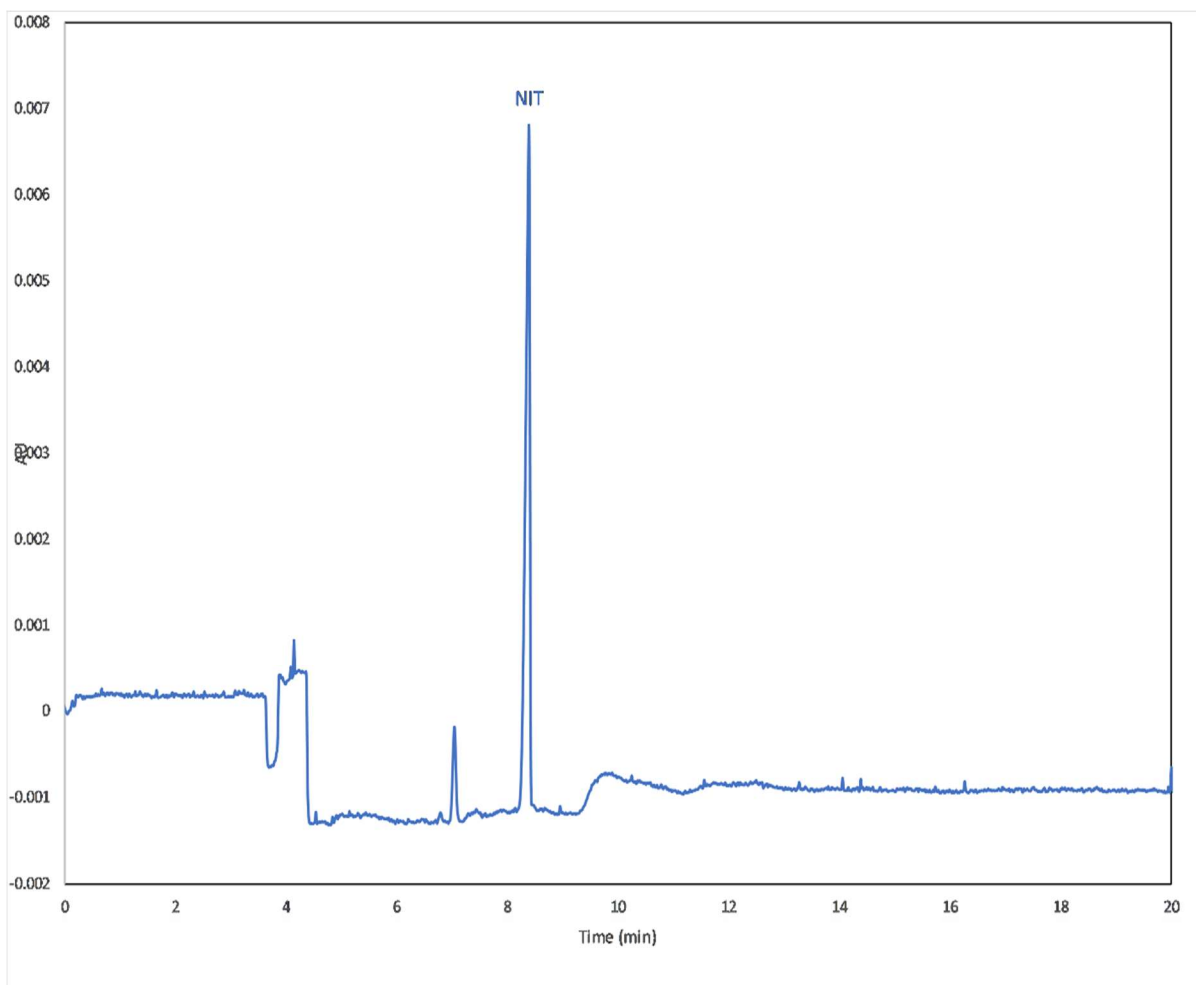

Fig. 4.13. Electropherogram for well water 2A (BGE - 20 mM sodium carbonate-sodium bicarbonate, pH 10.0, wavelength 214 nm). Target peaks of and nitarsone at the expected migration time is observed in this sample, however, no peak is seen for the roxarsone analyte.

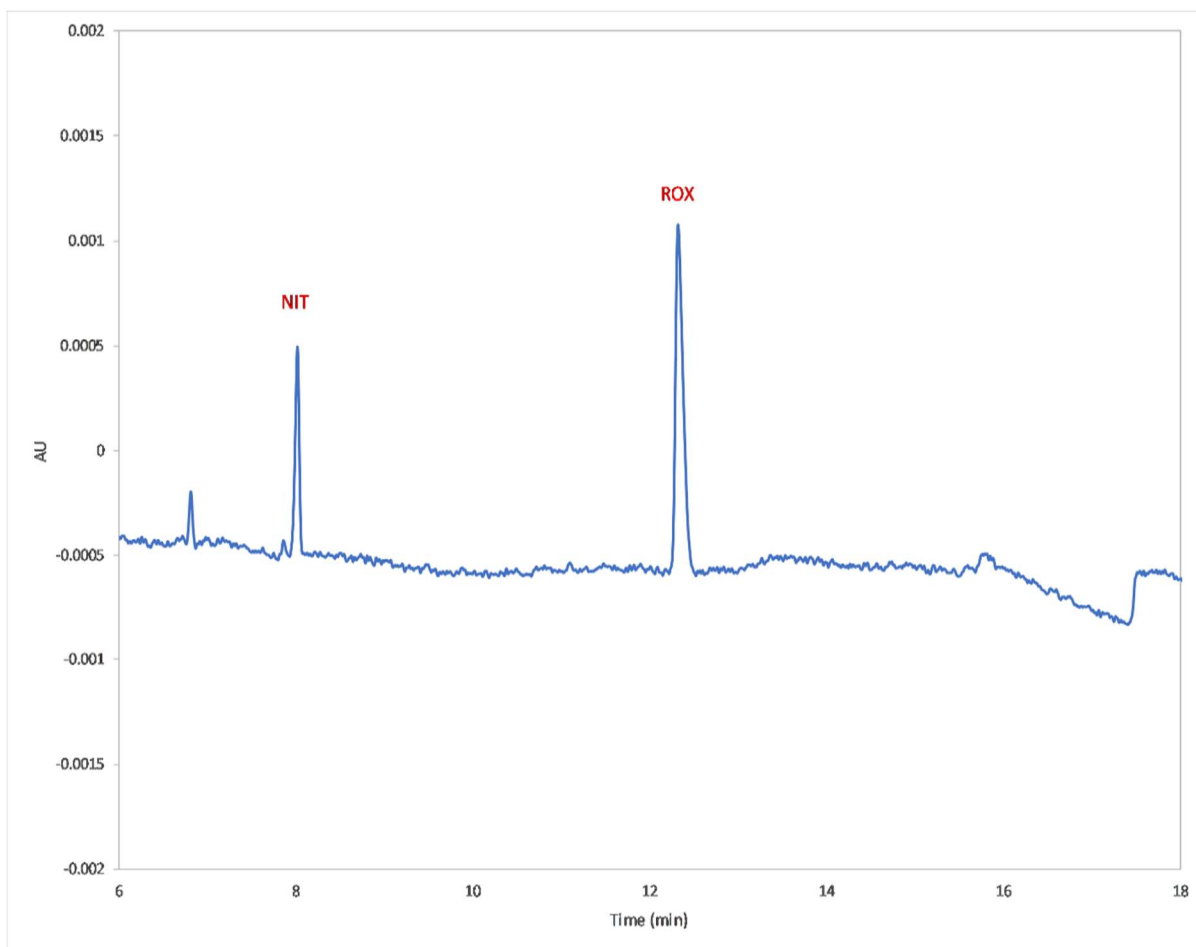

Fig. 4.14. Electropherogram of analysis of trough water A (BGE - 20 mM sodium carbonate-sodium bicarbonate, pH 10.0, wavelength 214 nm). Target peaks of roxarsone and nitarsonic both emerging at their expected migration time were observed in this sample.

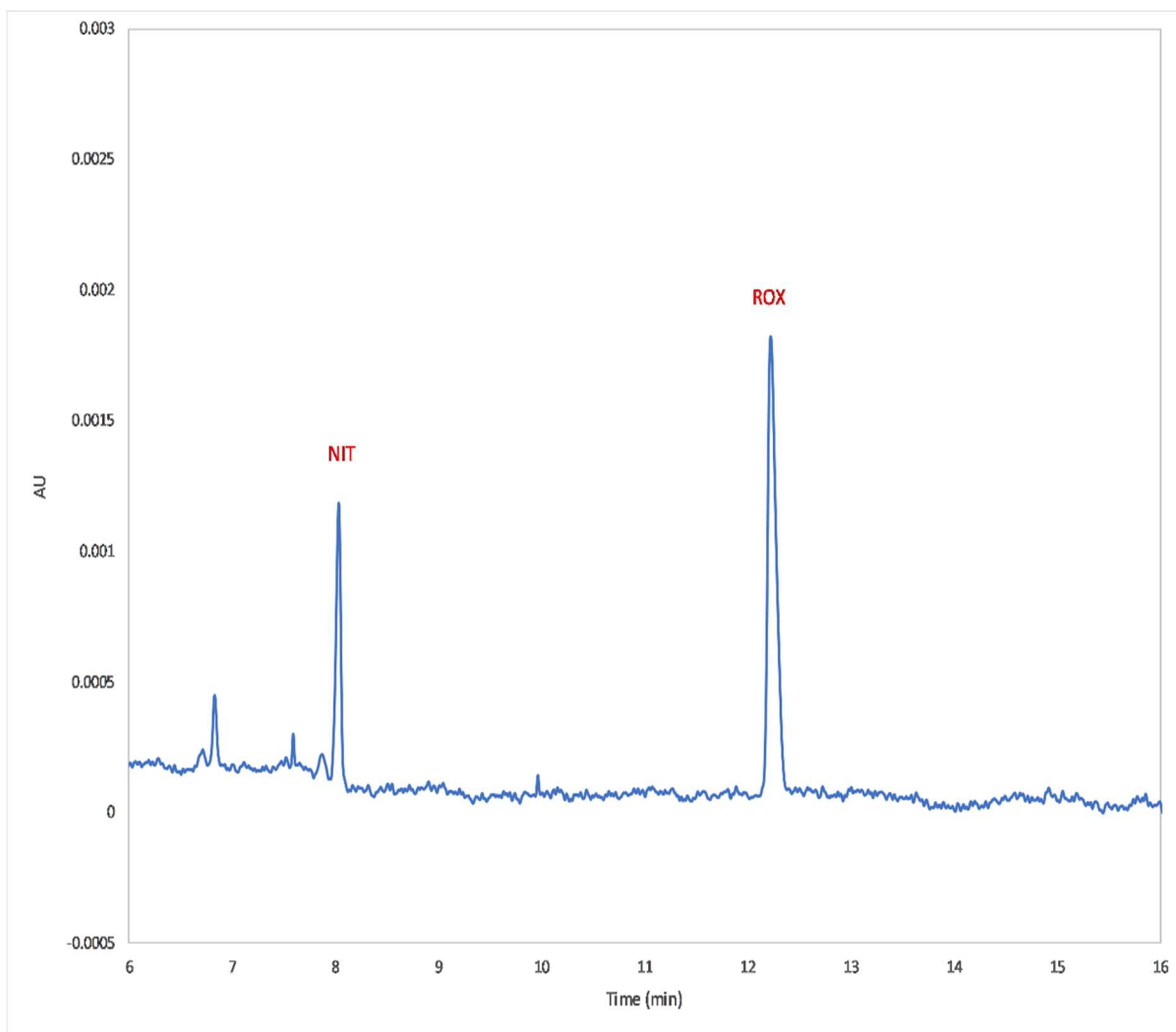

Fig. 4.15. Electropherogram of analysis of well water 1B (BGE - 20 mM sodium carbonate-sodium bicarbonate, pH 10.0, wavelength 214 nm). Target peaks of roxarsone and nitarsone both emerging at their expected migration time were observed in this sample.

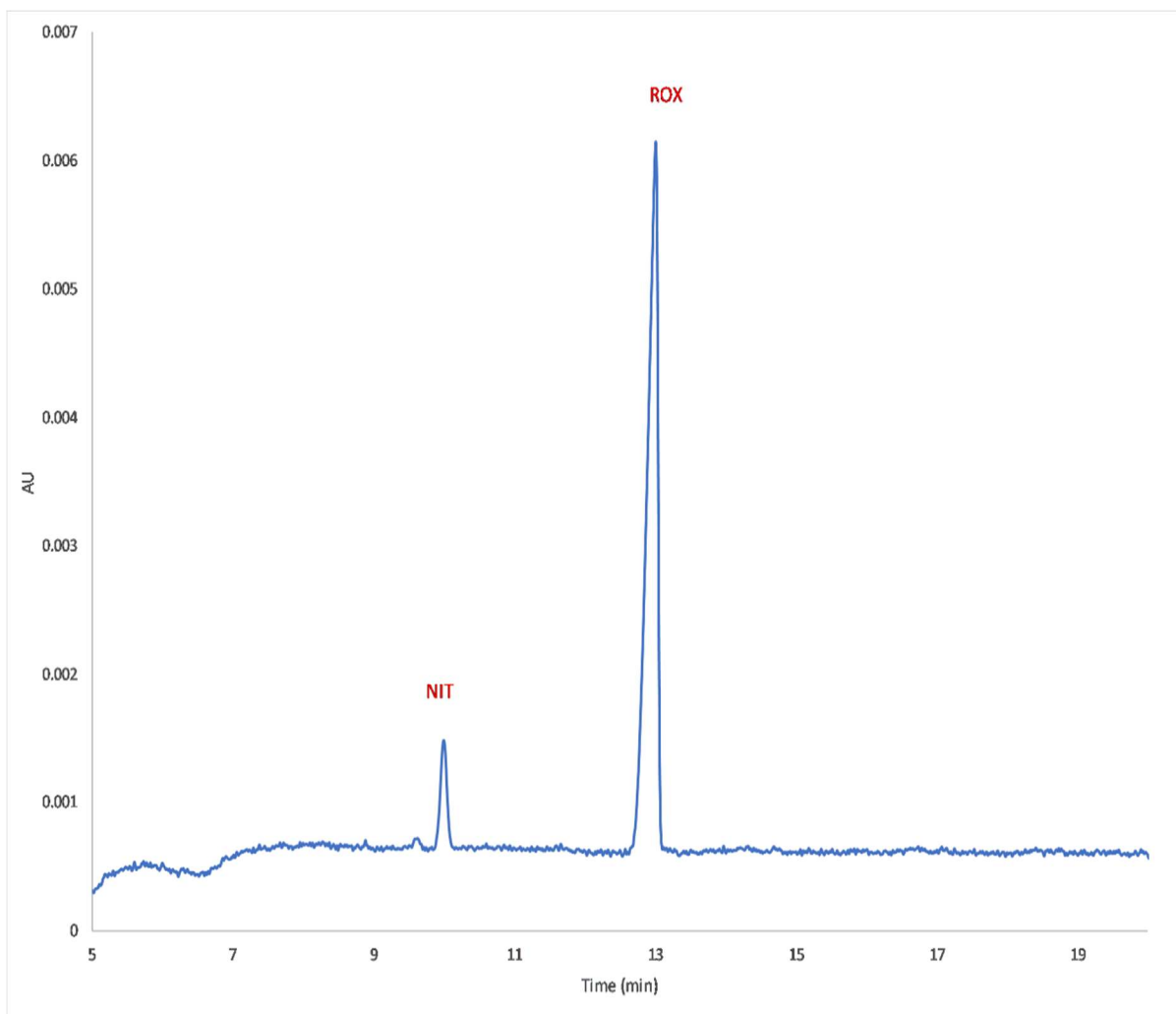

Fig. 4.16. Electropherogram of analysis of tap water 1A (BGE - 20 mM sodium carbonate-sodium bicarbonate, pH 10.0, wavelength 214 nm). Peaks of both nitarsonsone and roxarsone were observed at their expected migration time for this sample.

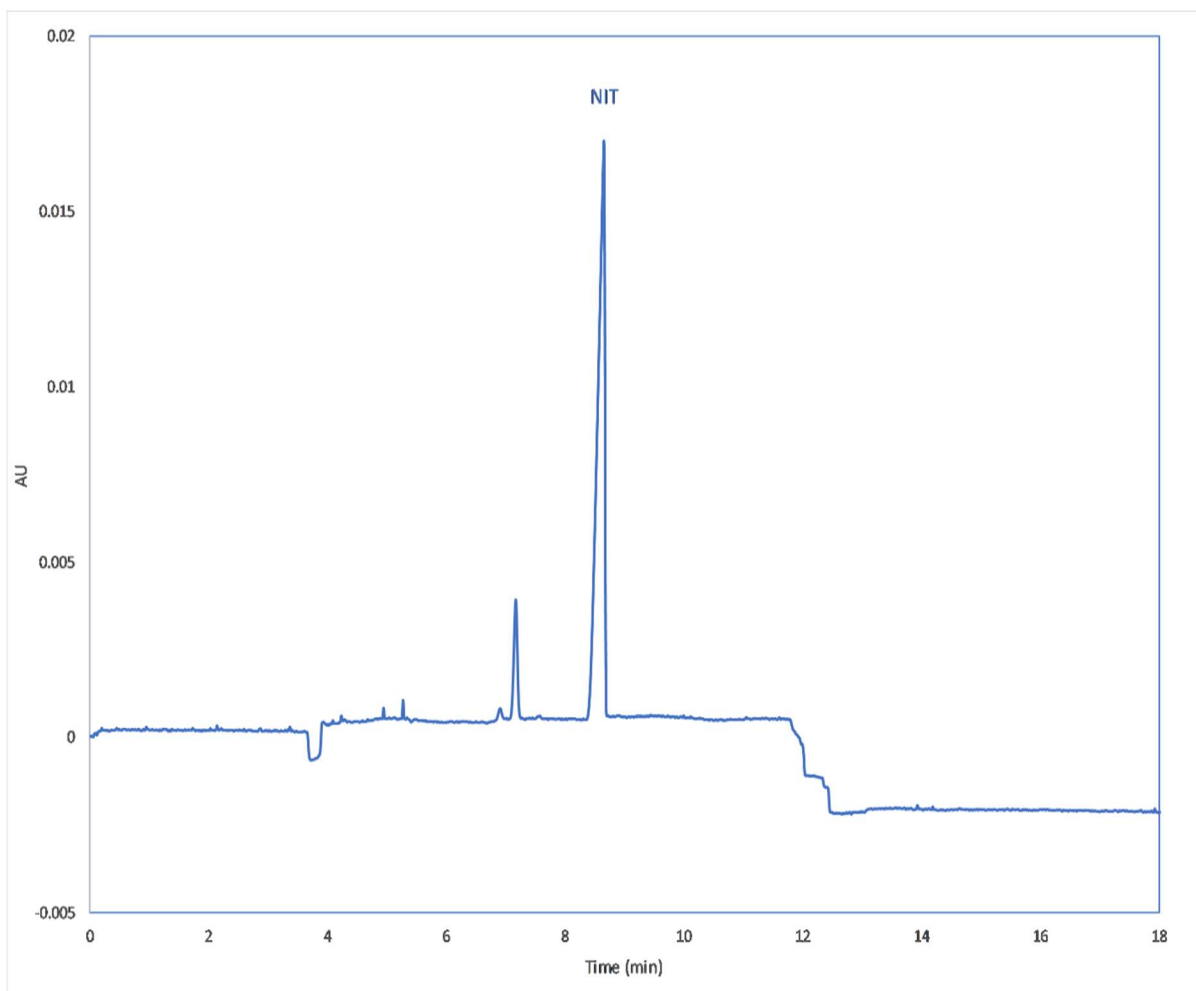

Fig. 4.17. Electropherogram of analysis of well water 2B (BGE - 20 mM sodium carbonate-sodium bicarbonate, pH 10.0, wavelength 214 nm). Analyte peak observed at 8.2 min which is the migration time for nitarsonic. No peaks were found for roxarsone in this sample.

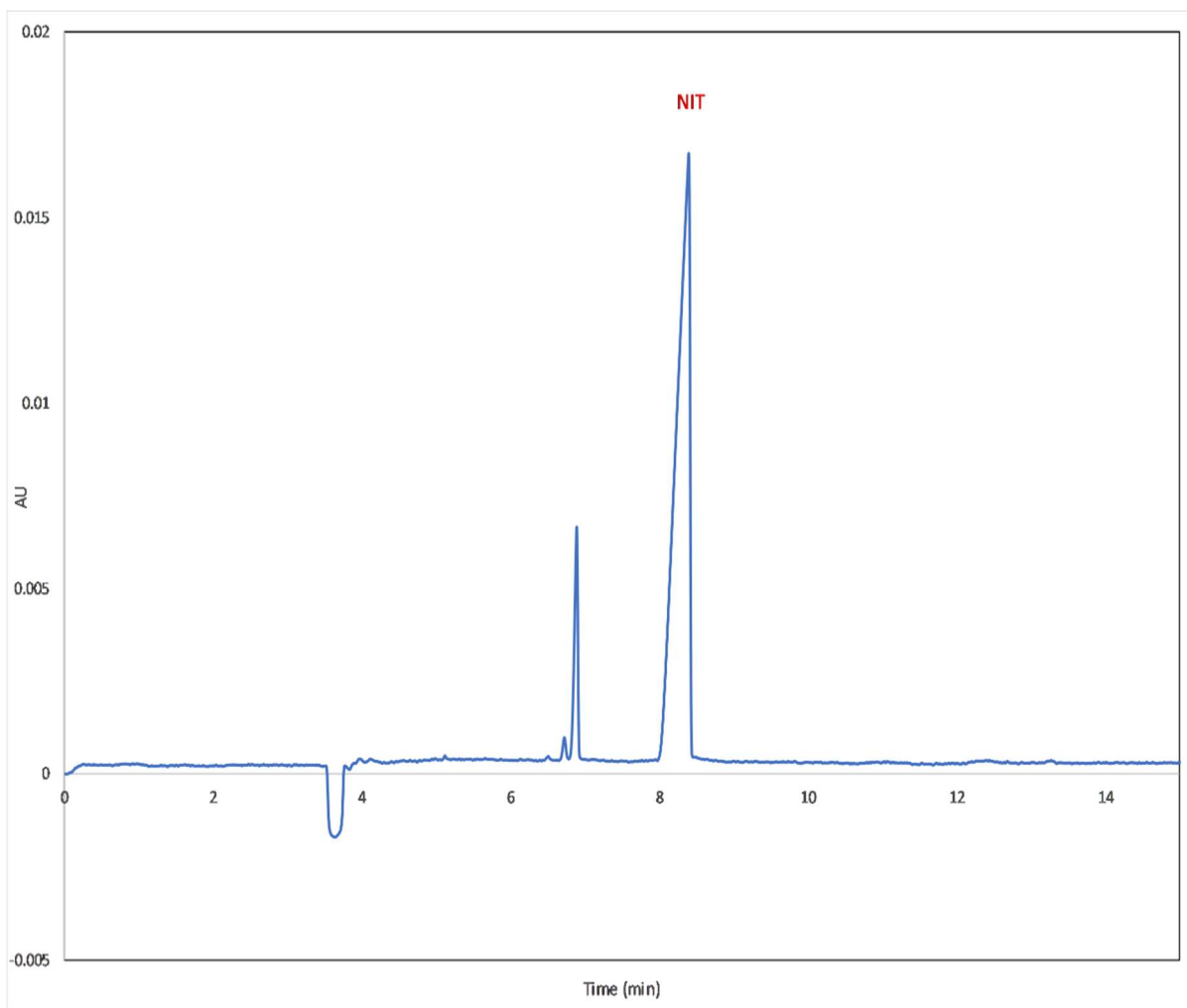

Fig. 4.18. Electropherogram of analysis of trough B (BGE - 20 mM sodium carbonate-sodium bicarbonate, pH 10.0, wavelength 214 nm). The analyte peak was seen at 8.0 min which is the migration time for roxarsone. This sample contains nitarsone and some possible metabolites of arsenic seen in 6.8 min but contains no roxarsone as peaks were not observed at its migration time.

CHAPTER 5

CONCLUSION AND FUTURE WORK

Conclusion

In this work, a rapid and sensitive analytical method for the qualitative and quantitative analysis of roxarsone and nitarsonic acid in environmental waters using capillary electrophoresis was successfully developed. This method is selective and sensitive for the simultaneous detection of roxarsone and nitarsonic acid. The method was developed using the background electrolyte (BGE) of 20 mM sodium carbonate-sodium bicarbonate which provided total separation of roxarsone and nitarsonic acid. The intraday and interday analysis indicated good reproducibility since the % RSD of peak area and migration time were less than 10%. This confirmed that the capillary electrophoresis method developed for the analysis of roxarsone and nitarsonic acid is reproducible. The percent recoveries for the 10 samples ranged from 83% to 112% and this indicates the method is accurate. Other short peaks appeared in most of the electropherogram which may probably be for metabolites of arsenic, however, their peaks do not increase consistently, and they do not interfere with the target analytes. The values for both LOD and LOQ for roxarsone were 449 ppb and 1360 ppb, respectively, while the LOD and LOQ values for nitarsonic acid were found to be 149 ppb and 452 ppb, respectively. Capillary electrophoresis has proven to be sensitive and rapid and can simultaneously determine the concentration of organoarsenicals (nitarsonic acid and roxarsone) in farm water samples. This ability can enable environmental specialists to analyze these and other organoarsenicals in farm water for their occurrence and to investigate their toxicity of these analytes to marine life and also to ensure they are present within permissible limits.

Future Work

Roxarsone and nitarsonic acid are degradable. They break down into inorganic forms of arsenic. For environmental water such as farm waters, the degradation could be monitored to characterize the degradation products. The CE method developed is sensitive and robust and can be an alternative analytical approach to investigate organoarsenicals and their by-products in environmental water.

Roxarsone and nitarsonic acid are excreted as part of poultry litter. This litter is used in land application as fertilizer. It is imperative for the government and environmental agencies to investigate the soil and plants grown on such lands to ensure that these organoarsenicals are not indirectly transferred to humans and animals.

Other methods of analysis can be incorporated to validate the capillary electrophoresis method developed for this analysis. HPLC and LC/MS will be great techniques to consider for comparative studies. The challenge in this research is in developing a method that selectively determines roxarsone and nitarsone because other forms of arsenic seem to be present in matrix. These other forms of arsenic can be investigated and identified.

The LOD and LOQ determined from this study are good but can be improved upon. Further analysis can be done with solid phase extraction in order to obtain lower limits of detection and quantification.

REFERENCE

- An, J., Wang, X., Ming, M., Li, J., Ye, N. Determination of sulfonamides in milk by capillary electrophoresis with PEG@MoS₂ as a dispersive solid-phase extraction sorbent. *R. Soc. Open Sci.*, **2018**, *5*, 1-6.
- Arai Y., Lanzirotti A., Sutton S, Davis J. A, Sparks D. L. Arsenic speciation and reactivity in poultry litter. *Environ. Sci. Technol.* **2003**, *37*, 4083-4090.
- Armubuster D.A. Pry T. Limit of Blank, Limit of Detection and Limit of Quantitation. The Clinical Biochemist Reviews. *Clin Biochem. Rev.* **2008**, *1*, S49-S52.
- Arnett S. D., Lunte C. E. 2003. Investigation of the mechanism of pH-mediated stacking of anions for the analysis of philological samples by capillary electrophoresis. *Electrophoresis*, **2003**, *24*, 1745-1752.
- Adak, A., Mangalgiri, Lee, J., Blaney, L. UV irradiation and UV-H₂O₂ advanced oxidation of the roxarsone and nitarosone organoarsenicals. *Water Research*, **2015**, *70*, 74-85.
- Alvarez-Rivera G., Cifuentes A., Castro P. Electrophoretic Technique: Capillary Zone Electrophoresis. Modern Techniques for Foods Authentication, 2nd Edition. Wiley, Weinheim. **2018**, 659-685.
- Almeda S., Arce L., Valcarcel M. Combined use of supported liquid membrane and solid phase extraction to enhance selectivity and sensitivity in capillary electrophoresis for the determination of ochratoxin A in wine. *Electrophoresis*, **2008**, *29*, 1573-1581.
- Arroyo-Abad, U., Mattusch, J., Möder, M., Elizalde-González, M. P., Wennrich, R., Matysik, F.-M. Identification of roxarsone metabolites produced in the system: Soil-chlorinated water-light by using HPLC-ICP-MS/ESI-MS, HPLC ESIMS/ MS and High-Resolution Mass Spectrometry (ESI-TOF-MS). *J. Anal. Atom. Spectrom.*, **2011**, *26*, 171-177.
- Ashjaei, S., Miller, W., Cabrera, M., Hassan, S. Arsenic in soils and forages from poultry litter-amended pastures. *Int. J. Environ. Res. Public Health.* **2011**, *8*, 1534-1546.
- Baker D. R. Capillary Electrophoresis. Techniques in Analytical Chemistry. Wiley, New York. **1995**, 1-2.

Bayse S. G., Hammonds-Odie, Jackson M. K., Tucker K. D., Kirlin G. W. Permeation of roxarsone and its metabolites increases caco-2 cell proliferation. *Adv. Biol. Chem.* **2013**, *3*, 389-396.

Beck W., Engelhardt H. Capillary electrophoresis of organic and inorganic cations with indirect UV detection. *Chromatographia*, **1992**, *33*, 313-316.

Beck W., van Hoek R., Englehardt H. Application of a diode-array detector in capillary electrophoresis. *Electrophoresis*. **1993**, *14*, 540-546.

Bednar A.J. Garbarino J. R., Ranville J. F., Wildeman T. R. Presence of organoarsenicals used in cotton production in agricultural water and soil of the Southern United States. *J. Agric. Food Chem.*, **2002**, *50*, 7340-7344.

Bednar A.J., Garbarino J. R., Ferrer I., Rutherford D. W., Wershaw R. L., Ranville J. F., Wildeman T. R. Photodegradation of roxarsone in poultry litter leachates. *The Science of Total Environment*. **2002**, *302*, 237-245.

Benramdane L., Accominotti M., Fanton L., Malicier, Vallon J. Arsenic speciation in human organs following fatal arsenic trioxide poisoning - A case report. *Clin. Chem.*, **1999**, *45*, 301-306.

Bernel E. Limit of Detection and Limit of Quantification Determination in Gas Chromatography. IntechOpen, **2014**. DOI: 10.5772/57341. Available from: <https://www.intechopen.com/books/advances-in-gas-chromatography/limit-of-detection-and-limit-of-quantification-determination-in-gas-chromatography>. (accessed January, 2020).

Breadmore M. C., Haddad P. R. Approaches to enhancing the sensitivity of capillary electrophoresis methods for the determination of inorganic anions. *Electrophoresis*, **2002**, *22*, 2464-2489.

Breadmore M. C., Thabano J. R. E., Dawo M., Kazarian A. A., Quirino J. P., Guijt R. M. Recent advances in enhancing the selectivity of electrophoresis and electrochromatography in capillaries and microchips (2006-2008). *Electrophoresis*, **2009**, *30*, 230-248.

Burgi D. S., Chien R. L. Application and Limits of Sample Stacking in Capillary Electrophoresis, In: Altria K.D. (eds) Capillary Electrophoresis Guidebook. *Methods. Mol Biol*, Vol. 52, Humana Press, Totowa. **1996**.

Chen, D., Zhang, H., Tao, Y., Wang, Y., Huang, L., Liu, Z., Yuan, Z. Development of a high-performance liquid chromatography method for the simultaneous quantification of four organoarsenic compounds in the feeds of swine and chicken. *J. Chromatogr. B*, **2011**, 879, 716-720.

Chen, J., Rosen, B. P. Organoarsenical Biotransformation by *Shewanella putrefaciens*. *Environ. Sci. Technol.*, **2016**, 50, 7956-7963.

Chen N., Wao Y., Ai Z., Jia F., Zhang L. Fast transformation of roxarsone into toxic species with ferrous iron and tetrapolyphosphate. *Environ. Chem. Lett.* **2018**, 17, 1077-1084.

Chen L., Lin J., Naidu R. Separation of arsenic species by capillary electrophoresis with sample-stacking techniques. *Anal. Bio. Chem.* **2005**, 375, 679-684.

Chapman H. D., Johnson, Z. B. Use of antibiotics and roxarsone in broiler chickens in the USA: analysis for the years 1995 to 2000. *Poult. Sci.* **2002**, 81, 356-364.

Cifuentes A., Simo C. Mass Spectrometry detection in capillary electrophoresis. *Comp. Anal. Chem.* **2005**, 45, 441-517.

Chien R. L. Burgi D. D. On-column sample concentration using field amplification in CZE. *Anal. Chem.*, **1992**, 64, 489A-496A.

Cortinas I., Field A. J., Kopplin M., Garbarino R. J., Gandolfi A. J., Sierra-Alvarez R. (2006). Aerobic biotransformation of roxarsone and related n-substituted phenylarsonic acids. *Environ. Sci. Technol.* **2006**, 40, 2951-2957.

Dabeka R. W., McKenzie A. D., Lacroix G. M., Cleroux C, Bowe S, Graham R. A., Conacher H. B. Survey of arsenic in total diet food composites and estimation of the dietary intake of arsenic by Canadian adults and children. *JAOAC Int*, **1993**, 76, 14-25.

de Boer T., de Zeeuw R. A., de Jong G. J., Ensing K. Selectivity in capillary electrokinetic separations electrophoresis. *Anal. Chem.* **1999**, 20, 2989-3010.

de Jesus F. F., Coelho A. G., de Assis P. L., da Silva, A. F. J., Daniel D., de Jesus D. P. Simple and fast method for simultaneous determination of propionate and sorbate in bread by capillary electrophoresis with UV spectrophotometric detection. *J. Food Compost. Anal.*, **2018**, 72, 93-96.

de Jong G. Capillary Electrophoresis- Mass Spectrometry (CE-MS): Principles and applications, **2016**, Retrieved from <https://ebookcentral.proquest.com>. (accessed December 2019).

Fayez, Y. M., Hegazy, M. A. Micellar electrokinetic chromatography (MEKC) with multiresponse chemometric optimization for the determination of hydrochlorothiazide and coformulated antihypertensives in the presence of hydrochlorothiazide major impurity. *J. Chromatogr. Sci.*, **2016**, 54, 1050-1060.

Fahram L. J., Albrecht M. E., McDonnell J. P. Atomic Absorption spectrophotometric determination of 4-hydroxy-3-nitrobenzenearsonic acid (roxarsone) in premixes. *J. Assoc. Off. Anal. Chem.* **1975**, 58, 945-948.

Fisher D. J., Yonkos L. T., Staver, K. W. Environmental concerns of roxarsone in broiler poultry feed and litter in Maryland, USA. *Environ. Sci. Technol.* **2015**, 49, 1999-2012.

Frenz J., Hancock W. High Performance Capillary Electrophoresis. *Trends Biotechnol.* **1991**, 1, 243-250.

Fuller, R. R., Sweedler, J. V. Factors affecting quantitative electrokinetic injections from submicroliter conductive vials in capillary electrophoresis. *Anal. Chem.*, **1999**, 71, 4014-4022.

Garbarino J. R., Bednar A. J., Rutherford D. W. Environmental fate of roxarsone in poultry litter. I. Degradation of roxarsone during composting. *Environ. Sci. Technol.*, **2003**, 37, 1509-1514.

Gillogly J. A., Lunte C. E. pH-mediated acid stacking with reverse pressure for the analysis of cationic pharmaceuticals in capillary electrophoresis. *Electrophoresis*, **2005**, 26, 633-639.

Roizing G. P., Dermaux A., Sandra P. Instrumentation for capillary electrochromatography. *J. Chrom. Lib.* **2001**, 62, 39-85.

Gong, M., Zhang, N., Maddukuri, N. Flow-gated capillary electrophoresis: A powerful technique for rapid and efficient chemical separation. *Anal. Methods*, **2018**, *10*, 3131-3143.

Tian, G., Zhu, X. Capillary Electrophoresis. *Convergence*. **2015**, *20*, 675-699.

Han F. X., Kingery W. L., Selim H. M., Gerard P. D., Cox M. S., Oldham J. L. Arsenic solubility and distribution in poultry litters and granulated products. *J. Appl. Poult. Res.* **2007**, *16*, 350-360.

Hancu, G., Simon, B., Rusu, A., Mircia, E., Gyéresi, Á. Principles of micellar electrokinetic capillary chromatography applied in pharmaceutical analysis. *Adv. Pharm. Bull.*, **2013**, *3*, 1-8.

Harris D. C., Lucy C. A. Quantitative Chemical Analysis. 10th Edition. W. H. Freeman & Co. New York. **2019**, 549-582.

Hayes M. A., Kheterpal I., Ewing A. G. Effects of buffer on pH on electroosmotic flow control by an applied radial voltage for capillary zone electrophoresis, *Anal Chem.*, **1993**, *65*, 27-31.

Hanrahan G., Gomez F. Chemometric methods in capillary electrophoresis. **2010**, 113-118. Retrieved from <https://ebookcentral.proquest.com> (accessed December 2019).

Heller, C., Slater, G. W., Mayer, P., Dovichi, N., Pinto, D., Viovy, J. L., Drouin, G. Free-resolution electrophoresis of DNA. *J. Chromatogr. A*, **1998**, *806*, 113–121.

Hirokawa T. Capillary Electromigration Separation Methods. Chapter 8 - Capillary Isotachophoresis. Elsevier, Amsterdam. **2018**, 189-208.

Horká, M., Šlais, K., Karásek, P., Růžička, F., Šalplachta, J., Šesták, J., Roth, M. Capillary electrophoresis in a fused-silica capillary with surface roughness gradient. *J. Sep. Sci.*, **2016**, *39*, 3827-3834.

Huang X., Gordon M. J., Zare R. N. Bias in quantitative capillary zone electrophoresis caused by Electrokinetic sample injection. *Anal. Chem.*, **1988**, *60*, 375-377.

Hutterer, K. M., Jorgenson, J. W. Ultrahigh-voltage capillary zone electrophoresis. *Anal. Chem.*, **1999**, *71*, 1293-1297.

Huber C., Holzl G. Chapter 8- Hyphenation of capillary electrochromatography and Mass Spectrometry: Instrumental Aspects, Separation Systems, and Applications. *J. Chroma. Lib.* **2001**, *62*, 271-316.

Ilko D., Holzgrabe U. Influence of the capillary diameter on the separation efficiency and sensitivity: a systematic approach. *Electrophoresis*. **2012**, *33*, 1494-1498.

Issaq H. J., Atamna I. Z., Muschik G. M. The effect of electric field strength, buffer type and concentration on separation parameters in capillary zone electrophoresis. *Chromatographia*, **1991**, *32*, 155-161.

Jaafar J., Irwan Z., Ahamad R., Terabe S., Ikegami T., Tanaka N. Online preconcentration of arsenic compounds by dynamic pH junction-capillary electrophoresis. *J. Sep. Sci.* **2007**, *30*, 391-398.

Jackson, B. P., Bertsch, P. M., Cabrera, M. L. Camberato, J. J. Seaman, J. C. Wood, C. W. Trace element speciation in poultry litter. *J. Environ. Qual.*, **2003**, *32*, 535-540.

Jackson B. P., Seaman J. C., Bertsch P. M. Fate of arsenic compounds in poultry litter upon land application. *Chemosphere* **2006**, *65*, 2028-2034.

Jackson B. P., Miller W. P. Soluble arsenic and selenium species in fly ash/organic waste amended soils using ion chromatography-inductively coupled plasma mass spectrometry. *Environ. Sci. Technol.* **1999**, *33*, 270-275.

Jones T. F. A broad view of Arsenic, *Poultry Science*, **2007**, *86*, 2-14.

Jumppanen J. H., Riekkola M. L. Influence of electrolyte on the effective electric field strength in capillary zone electrophoresis. *Electrophoresis*, **1995**, *1*, 1441-1444.

Karabult B., Tapramaz R. EPR study of gamma irradiated arsinilic acid single crystal. *Radiat. Phys. Chem.*, **1999**, *55*, 33-335.

Kiranmayi P., Asok A., Lee B. Organoarsenicals in poultry litter: Detection, fate and toxicity. *Environ. Int.* **2015**, *75*, 68-80.

Konkel L. Organoarsenic drugs over time: The pharmacokinetics of roxarsone in chicken meat. *Environ Health Perspect.* **2016**, *124*, 150.

Kok, W. Capillary Electrophoresis: Instrumentation and Operation. *Quaternary Science-Reviews – Quat. Sci. Rev.* **2000**, *51*, 4-10.

Krivácsy, Z., Gelencsér, A., Hlavay, J., Kiss, G., Sárvári, Z. Electrokinetic injection in capillary electrophoresis and its application to the analysis of inorganic compounds. *J. Chromatogra A*, **1999**, *834*, 21–44.

Kapaj S., Peterson H., Liber K., Bhattacharya P. Human Health Effects from Chronic Arsenic Poisoning - A Review. *J. Environ. Sci. Health Part A*, **2006**, *41*, 2399-2428.

Kubáň, P., Foret, F., Erny, G. Open source capillary electrophoresis. *Electrophoresis*, **2019**, *40*, 65-78.

Lee, H. G., Kwon, J. Y., Chung, D. S. Sensitive arsenic speciation by capillary electrophoresis using UV absorbance detection with on-line sample preconcentration techniques. *Talanta*, **2018**, *181*, 366-372.

Liu Y. M., Cheng J. K. Elemental Speciation analysis in capillary electrophoresis. *Electrophoresis*, **2003**, *24*, 1993-2012.

Li J. Ionic Liquids in Lipid Processing and Analysis. Chapter 14- Ionic Liquids in Lipid Analysis. Academic Press, Denmark. **2016**, 423-458.

Li, J., Pawitwar, S. S., Rosen, B. P. The organoarsenical biocycle and the primordial antibiotic methylarsenite. *Metallomics*, **2016**, *10*, 1047-1055.

Li, S. F. Y., Wu, Y. S. Capillary electrophoresis. *Anal. Chem.*, **1988**, *60*, 1176-1187.

Liao N., Seto E., Eskenazi B., Wang M., Li Y., Hua J. A comprehensive review of arsenic exposure and risk from rice and a risk assessment among a cohort of adolescents in Kunming, China. *Int. J. Enviro. Res. Public Health*. **2018**, *15*, 2191-2207.

Liu Y., Zhang Z., Li Y., Fei Y. Response of microbial communities to roxarsone under different culture conditions. *Can. J. Microbiol.* **2016**, 1-23.

Liu Q, peng H., Zuidhof M. J., Li X. F., Le X. C. Arsenic species in chicken breast: temporal variations of metabolites, elimination kinetics, and residual concentrations. *Environ. Health Perspect.* **2016**, *124*, 1174-1181.

Liu, Y., Fanguy, J. C., Bledsoe, J. M., Henry, C. S. Dynamic coating using polyelectrolyte multilayers for chemical control of electroosmotic flow in capillary electrophoresis microchips. *Anal. Chem.*, **2000**, *72*, 5939-5944.

Lu, D., Ji, F., Wang, W., Yuan, S., Hu, Z.-H., Chen, T. Adsorption and photocatalytic decomposition of roxarsone by TiO₂ and its mechanism. *Environ. Sci. Pollut. Res.* **2014**, *21*, 8025-8035.

Manuel S. *Electrophoresis.* **2007**, *28*, 174-192.

Milton, A. H., Smith, W., Rahman, B., Hasan, Z., Kulsum, U., Dear, K., Ali, A. Chronic arsenic exposure and adverse pregnancy outcomes in Bangladesh. *Epidemiology*, **2005**, *16*, 82-86.

Morrison J. L. Thin layer chromatographic identification of organoarsenic feed additives in feeds. *J. Agric. Food Chem.* **1968**, *16*, 704-705.

MacDougal D., Crumett, W B. "Guidelines for data quality acquisition and data evaluation in environmental chemistry" *Anal. Chem.*, **1980**, *52*, 2242-49.

Mazereeuw, M., Tjaden, U. R., Reinhoud, N. J. Single Capillary Isotachophoresis--Zone Electrophoresis: Current Practice and Prospects, A Review. *J. Chromatogr. Sci.*, **1995**, *33*, 686-697.

Melanson, J. E., Baryla, N. E., Lucy, C. A. Dynamic capillary coatings for electroosmotic flow control in capillary electrophoresis. *TrAC - Trends Anal. Chem.*, **2011**, *20*, 365-374.

Moore P. A., Daniel T. C., Gilmour J. T., Shreve B. R., Edwards D. R., Wood B. H. Decreasing metal runoff from poultry litter with aluminum sulfate. *J. Environ. Sci. Technol.* **2003**, *37*, 1509-1514.

Morrison J. L. Distribution of arsenic from poultry litter in broiler chickens, soil, and crops. *J. Agric. Food Chem.* **1969**, *17*, 1288-1290.

Mudgett, P. D., Schultz, J. R., Sauer, R. L. Evaluation of capillary electrophoresis for in-flight ionic contaminant monitoring of SSF potable water. *SAE Technical Papers*, **1992**, 101, 888-897.

Nachman E. K., Love D. C., Baron P. A., Nigra A. E., Murko M., Raber G., Francesconi, Navas-Acien A. Nitarsone, Inorganic Arsenic, and Other Arsenic Species in Turkey Meat: Exposure and Risk Assessment Based on a 2014 U. S. Market Basket Sample. *Environ. Health Perspect.* **2017**, 125, 363-369.

Nachman, K. E., Baron, P. A., Raber, G., Francesconi, K. A., Navas-Acien, A., Love, D. C. Roxarsone, inorganic arsenic, and other arsenic species in chicken: A U.S.-based market basket sample. *Environ. Health Perspect.*, **2013**, 121, 818-824.

Needleman S. B., Romberg R. W. Limits of linearity and detection of some drugs of abuse. *J. Anal. Toxicol.* **1990**, 14, 34-38.

Nagy Kornel, Vekey K., Medical Applications of Mass Spectrometry. Elsevier, Washington, **2008**, 561-581.

Nigra A. E., Nachman K. Love. D. C., Grau-Perez M., Navas-Acien A. Poultry consumption and arsenic exposure in the U.S. population. *Environ. Health Perspect.* **2017**, 125, 370-377.

Opekar, F., Tůma, P. (2017). Hydrodynamic sample injection into short electrophoretic capillary in systems with a flow-gating interface. *J. Chromatogr. A*, **2017**, 1480, 93-98.

Otter D. Protein- Determination and Characterization. *Encyclopedia of Food Sciences and Nutrition*. Academic Press, Cambridge. **2003**, 4824-4830.

Pergantis Spiros, Winnik Witold, Betowski Don. Determination of Ten organoarsenic compounds Using Microbore High-performance Liquid Chromatography Coupled with Electrospray Mass Spectrometry-mass Spectrometry. *J. Anal At. Spectrom.* **1997**, 12, 531-536.

Perret D. Encyclopedia of Separation Science. *Electrophoresis*, **2000**, 103-118.

Poole C. Capillary-Electromigration Separation Techniques. The Essence of Chromatography. Elsevier, Amsterdam. **2003**, 8, 619-717.

Poole, S. K., Poole, C. F. Essential Guides to Method Development in Capillary Electrophoresis- Encyclopedia of Separation Science, Academic Press, Cheshire. **2000**, 4581-4592.

Pretorius V., Hopkins B. J., Schieke J. D. A new concept for high-speed chromatography. *Chromatogr.* **1974**, *99*, 23-31.

Quirino, J. P., Haddad, P. R. Online sample preconcentration in capillary electrophoresis using analyte focusing by micelle collapse. *Anal. Chem.*, **2008**, *80*, 6824-6829.

Rathore S. A. Joule heating and determination of temperature in capillary electrophoresis and capillary electrochromatography columns. *J. Chromatogr. A.* **2004**, *1037*, 431-443.

Ratnaike R. N. Acute and chronic arsenic toxicity. *Postgrad Ned J.* **2003**, *79*, 391-396.

Rizvi A. Do P., Saleh M. Fundamentals of micellar electrokinetic chromatography (MEKC). *Eur. J. Chem.* **2011**, *2*, 276-281.

Rosal G. C., Momplaisir G., Heithmar M. E. Roxarsone and transformation products in chicken manure: determination by capillary electrophoresis-inductively coupled plasma-mass spectrometry. *Electrophoresis.* **2005**, *26*, 1606-1614.

Rubio, R., Albertí, J., Padró, A., Rauret, G. On-line photolytic decomposition for the determination of organoarsenic compounds. *Trends Anal. Chem.*, **1995**, *14*, 274-279.

Rutherford, D. W., Bednar, A. J., Garbarino, J. R., Needham, R., Staver, K. W., Wershaw, R. L. Environmental fate of roxarsone in poultry litter. Part II. Mobility of arsenic in soils amended with poultry litter. *Environ. Sci. Tech.*, **2003**, *37*, 1515-1520.

Sadecka J., Polonsky J. Determination of some antirheumatics by capillary isotachopheresis. *Electrophoresis.* **2000**, *21*, 2842-2847.

Sato, S., Soga, T., Nishioka, T., Tomita, M. Simultaneous determination of the main metabolites in rice leaves using capillary electrophoresis mass spectrometry and capillary electrophoresis diode array detection. *Plant Journal*, **2004**, *40*, 151-163.

Saucedo-Velez A. A., Hinojosa-Reyes L., Villanueva-Rodriguez M., Caballero-Quintero A., Hernandez-Ramirez, Guzman-Mar J.L. Speciation analysis of organoarsenic compounds in livestock feed by microwave-assisted extraction and high-performance liquid chromatography coupled to atomic fluorescence spectrometry. *Food Chem.* **2017**, *232*, 493-500.

Santiago M., Strobel S. Laboratory methods in enzymology: Cell, lipid and carbohydrate. *Methods Enzymol.* **2013**, *533*, 2-347.

Schaeper J. P., Sepaniak M. J. Parameters affecting reproducibility in capillary electrophoresis. *Electrophoresis*, **2000**, *21*, 1421-1429.

Schimpf M. Tutorial: Capillary Electrophoresis. *Chem. Educat.* **1995**, *1*, 1430-1471.

Schmitt, P., Garrison, A. W., Freitag, D., Kettrup, A. Capillary isoelectric focusing (CIEF) for the characterization of humic substances. *Water Res*, **1997**, *31*, 2037-2049.

Schwartz H. E., Melera M., Brownlee R. G. Performance of an automated injection and replenishment system for capillary electrophoresis. *J. Chromatogr. A.*, **1989**, *480*, 129-139.

Shi M., Gao Q., Feng J., Lu Yongchao. Analysis of inorganic cations in honey by capillary electrophoresis. *J. Chromatogr. A*, **2012**, *50*, 547-552.

Shihabi Z. K., Hunsdale M. Some variable affecting reproducibility in capillary electrophoresis. *Electrophoresis*, **1995**, *16*, 2159-2163.

Shui M., Ji F., Tang R. Yuan S., Zhan X., Wang W., Hu Z. Impact of roxarsone on the UASB reactor performance and its degradation. *Front Environ. Sci. Eng.* **2016**, *10*, 1-9.

Shiple H. J., Yean S. J., Kan A. T., Tomson M. B. Adsorption of arsenic to magnetite nanoparticle concentration, pH, ionic strength, and temperature. *Environ. Toxicol. Chem.*, **2009**, *28*, 509-515.

Sims J. T., Wolf D. C. Poultry waste management – agricultural and environmental issues. *Adv. Agron.* **1994**, *52*, 1-83.

Singh N., Kumar D., Sahu A. P. 2007. Arsenic in the environment: Effects on human health and possible prevention. *J. Environ. Biol.* **2007**, *28*, 359-65.

Silberberg E. K., Nachman K. The environmental and public health risks associated with arsenical use in animal feeds. *Ann N Y Acad. Sci.* **2008**, *1140*, 346-357.

Simo C., Cifuentes A. Mass spectrometry detection in capillary electrophoresis. *Comp. Anal. Chem.* **2005**, *45*, 441-517.

Slampova A., Mala Z., Gebauer P. Recent Progress of Sample Stacking in capillary electrophoresis (2016-2018). *Electrophoresis*, **2018**, *40*, 40-54.

Smoluch M., Mielczarek P., Drabik A., Silberring J. Online and offline Sample fractionation. Preteomic Profiling and Analytical Chemistry. **2016**, *99*, 63-99.

Stolz F. J., Perera E., Kilonzo B., Kail B., Crable B., Fisher E., Ranganathan M., Wormer L., Basu P. Biotransformation of 3-Nitro-4-hydroxybenzene arsonic acid (roxarsone) and release of inorganic arsenic by *Clostridium* species. *Environ. Sci. Technol.* **2007**, *41*, 818-823.

Suba, D., Urbányi, Z., Salgó, A. Capillary isoelectric focusing method development and validation for investigation of recombinant therapeutic monoclonal antibody. *J. Pharmaceut. Biomed.*, **2015**, *114*, 53-61.

Sun, P., Armstrong, D. W. Ionic liquids in analytical chemistry. *Anal Chim. Acta.*, **2010**, *661*, 1-16.

Sun B., Macka M., Haddad P. R. Separation of organic and inorganic arsenic species by capillary electrophoresis using direct spectrophotometric detection. *Electrophoresis*, **2002**, *23*, 2430-2438.

Suqi L., Jing X., Chen W., Yu Y., Zizheng L., Jinjun L., Feng W. Multiple transformation pathways of p-arsinilic acid to inorganic arsenic species in water during UV disinfection. *J. Environ. Sci.* **2016**, *47*, 39-48.

Swartz m. E., Merion M. On-line preconcentration on a packet-inlet capillary for improving the sensitivity of capillary electrophoretic analysis of pharmaceuticals. *J. Chromatogr. A.*, **1993**, *632*, 209-213.

Swaran F. Arsenic: Chemistry, Occurrence, and Exposure. Handbook of Arsenic Toxicology. **2015**, 1-49.

Swaran F. Chapter 15- Arsenicals: Toxicity, Their Use as Chemical Warfare Agents, and Possible Remedial Measures. Handbook of Toxicology of Chemical Warfare Agents (2nd Edition) Academic Press, Kentucky. **2015**, 171-179.

Swinney, K., Bornhop, D. J. Detection in capillary electrophoresis. *Electrophoresis*, **2000**, *21*, 1239-1250.

Swinney K., Bornhop D. J. Quantification and evaluation of Joule heating in on-chip capillary electrophoresis. *Electrophoresis*, **2002**, *23*, 613-620.

Takahashi Y., Minamikawa R., Hattori, K. H, Kurishima, K, Kihou, N. Tuita K. 2004. Arsenic behaviour in Paddy fields during the cycle of Flooded and Non-flooded Period. *Environ. Sci. Technol.*, **2004**, *38*, 1038-1044.

Taylor T. Important aspects of UV Detection for HPLC. Liquid Chromatography Gas Chromatography North America, **2015**, *33*, 870-885.

Terabe S. *Anal. Chem.* **2004**, *76*, 240A-246A.

Thorslund S., Lindberg P., Andren P., Nikolajeff F., Bergquist J. Electrokinetic-driven microfluidic system in poly(dimethylsiloxane) for mass spectrometry detection integrating sample injection, capillary electrophoresis, and electrospray emitter on-chip. *Electrophoresis*. **2005**, *26*, 4674-4683.

Tchounwou, P. B., Patlolla, A. K., Centeno, J. A. Invited Reviews: Carcinogenic and systemic health effects associated with arsenic exposure—A Critical Review. *Toxicol. Pathol.*, **2003**, *31*, 575–588.

Thomas B. R., Fang X. G., Chen X., Tyrell R. J., Ghodbane S. Validated micellar electrokinetic capillary chromatography method for quality control of the drug substances hydrochlorothiazide and chlorothiazide. *J. Chromatogr. B.* **1994**, *657*, 383 -394.

Timperman A, Tracht E. E., Sweedler J. V. Dynamic On-column pH monitoring in capillary electrophoresis: Application volume-limited outlet vials. *Anal. Chem*, **1996**, *68*, 2693-2698.

Vahter M. Mechanisms of arsenic biotransformation. *Toxicology*, **2002**, 181-182, 211-217.

Vegvari A. Peptide and protein separations by capillary electrophoresis and electrochromatography. *Comp Anal. Chem.* **2005**, *46*, 149-252.

Weinberger R. Practical Capillary Electrophoresis Ch 8 – Injection. Academic Press, New York. **2000**, 321-364.

WHO. Arsenic and Arsenic Compounds. Environmental Health Criteria. *International Programme on Chemical Safety, WHO Geneva.* **2001**.

Wu T., Yu C., Li J., Li J. Minireview: Recent advances in the determination of flavonoids by capillary electrophoresis. *Instrum. Sci. Technol.*, **2018**, *46*, 364-386.

Yang, H. C., Rosen, B. P. New mechanisms of bacterial arsenic resistance. *Biomedical journal*, **2016**, *39*, 5-13.

Yang C. Y., Chang C. C., Tsai S. S., Chuang H. Y., Ho C. K., Wu T. N. Arsenic in drinking water and adverse pregnancy outcome in an arseniasis-endemic area in northeastern Taiwan. *Environ Res.* **2003**, *91*, 29-34.

Yang J., Sahana B., Hage D. S. Improved reproducibility in capillary electrophoresis through the use of mobility and migration time ratios. *J. Chromatogr. A.*, **1996**, *735*, 209-220.

Yao L., Huang L., Bai C., Zhou C., He Z. Effect of Roxarsone metabolites in chicken manure on soil biological property. *Ecotoxicol. Environ. Safe.* **2019**, *171*, 493-501.

Yu S. Zhou P., Feng A., Shen X., Zhang Z., Hu J. pH effect on dynamic coating for capillary electrophoresis of DNA. *Anal. Bioanal. Chem.* **2006**, *385*, 730-736.

Xu T., Kamat P. V., Joshi S., Mebel A. M., Yong C., O'Shea K. E. Hydroxyl radical mediated degradation of phenylarsonic acid. **2007**, *111*, 7819-7824.

Xu X, Kok W. Poppe H. Sensitive determination of sugars by CZE with indirect UV detection under highly alkaline conditions. *J. Chromatogr. A*, **1995**, *716*, 231-240.

Xu, Y. Tutorial: Capillary Electrophoresis. *Chem. Educator*, **1996**, *2*, 1-14.

Zhang H., Selim M. H. Kinetics of Arsenate Adsorption- Desorption in Soils. *Environ. Sci. Technol.* **2015**, *39*, 6101-6108.

Zhang, Z., Zhang, F., Liu, Y. Recent advances in enhancing the sensitivity and resolution of capillary electrophoresis. *J. Chromatogr. Sci.*, **2013**, *51*, 666-683.

Zhang L., Zhang W., Wang Z., Cheng J. Determination of histamine by capillary zone electrophoresis with amperometric detection. *Anal Sci.* **2002**, *18*, 1117-1120

Zhao D., Wang J., Yin D., Li M., Chen X., Juhasz A. L, Navas-Acien A., Li H. Ma L. Q. Arsinilic acid contributes more to total arsenic than arsenic than roxarsone in chicken meat from Chinese markets. *J. Haz Mat.*, **2020**, *383*, 121-178.

Zhao Y., Lunte C. E. pH-mediated field amplification on-column preconcentration of anions in physiological samples for capillary electrophoresis. *Anal. Chem.* **1999**, *71*, 3985-3991.

21 CFR 556.60. Code of Federal Regulations. Title 21- Food and Drugs: Chapter I-Food and Drug Administration, Department of Health and Human Services (Continued): Part 556_Tolerances for Residues of New Animal Drugs in Food-Subpart B: Table of Specific Tolerances for Residues of New Animal Drugs. Available from: <http://frwebgate.access.gpo.gov/cgi-bin/get-cfr.cgi>. (Accessed February 22, 2020).

APPENDIX

Appendix A

Method Validation Results

Table A. 1. Calculation of LOD and LOQ for roxarsone.

Peak area of 500 ppb roxarsone (n = 6)									SD	LOD (ppm)	LOQ (ppm)
Calibration curve: $y = 101280x + 13214$											
53486	49729	53729	56891	60431	59900	52247	49258	50547	4196	0.45	1.36

Table A. 2 Calculation of LOD and LOQ for nitarsone

Peak area of 500 ppb nitarsone (n=6)									SD	LOD (ppm)	LOQ (ppm)
Calibration curve: $y = 47374x - 3978.4$											
20179	20663	20396	21954	20608	22279	23767	24075	23742	1665	0.15	0.45

Table A.3. Percent recovery calculations for 5 samples of the first set.

The Calibration equation: $y = 101280x + 13214$ $R^2 = 0.989$

Sample Name	Spiked concentration (ppm)	Peak area	Δ Peak area	Spike (exp)	% Recovery
Tap Water 1	0	0	7508		
	1	101589	109097	0.95	94.7%
	5	567983	560475	5.48	109.6%
	10	1115166	1107658	10.88	108.8%
Tap water 2	0	0	4918		
	1	111356	106438	0.92	92.0%
	5	586714	581796	5.62	112.3%
	10	1092579	1087661	10.66	106.6%
Well water 1	0	0	10589		
	1	110504	99915	0.96	96.1%
	5	559521	548932	5.39	107.9%
	10	1025754	1015165	10.36	103.6
Well water 2	0	0	5011	1.06	105.6
	1	101586	106597	0.92	92.2%
	5	528965	533976	5.14	102.8%
	10	998746	1003757	9.78	97.8%
Trough water	0	11587	0		
	1	93731	106945	0.93	93.5%
	5	493658	505245	4.86	97.2%
	10	996589	1008176	9.71	97.1%

 Δ Peak area = Peak area (spiked) – peak area (unspiked)

Table A.4. First day intraday precision studies for peak areas and migration time of roxarsone.

Day 1	Concentration (ppm)	Peak area (n=3)			Mean	SD	% RSD
	0.5	53486	49729	53729	513240	2243	4.29
	5	515445	532300	519985	522576	8721	1.67
	10	970790	967547	1017736	985357	28087	2.85
	Concentration (ppm)	Migration time (n=3) (min)			Mean	SD	%RSD
	0.5	13.679	13.637	13.733	13.683	0.05	0.35
	5	13.387	13.413	13.496	13.496	0.06	0.42
	10	12.525	12.658	12.817	12.667	0.15	1.15

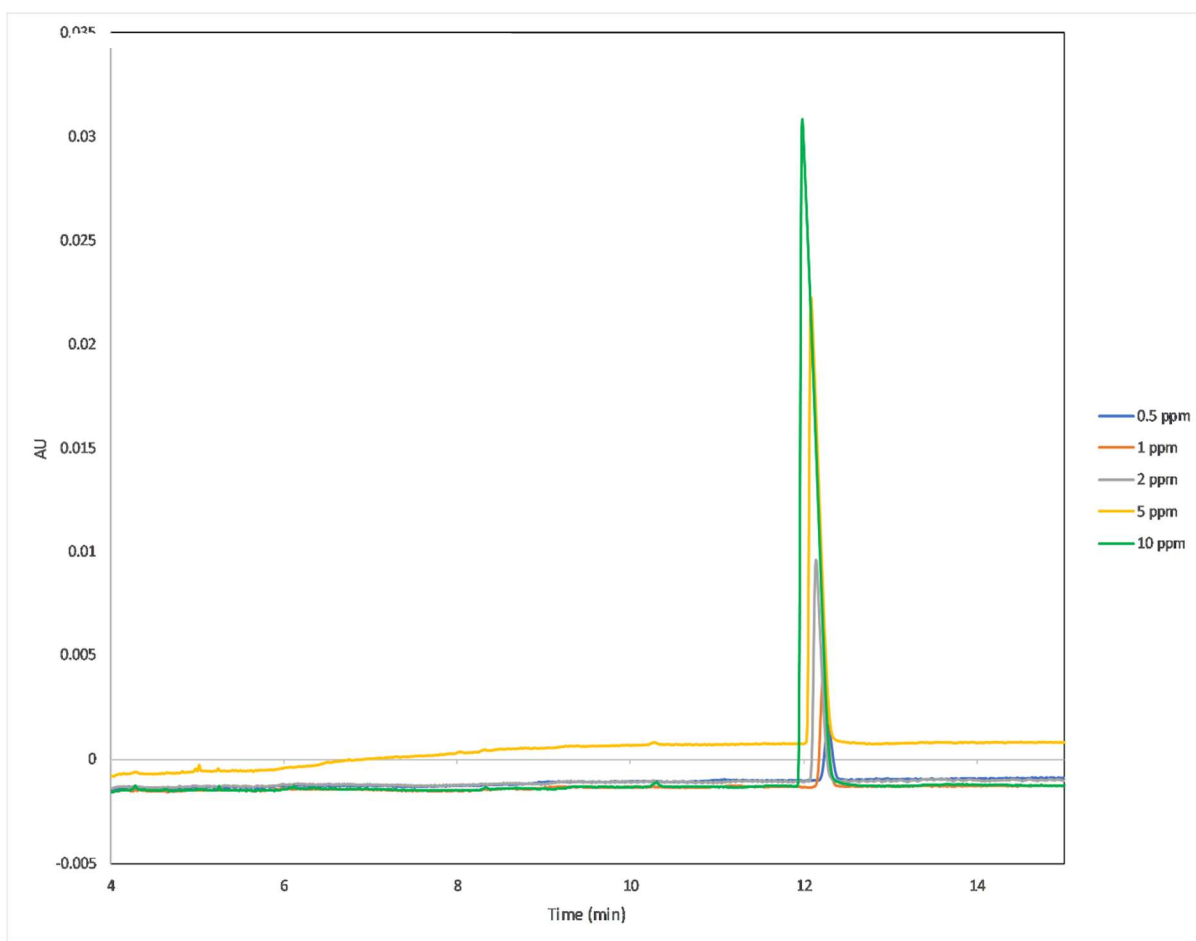

Fig. A.1. Standard addition of nitarsone using LVSS sample 1 well (0.5 ppm, 1 ppm, 5 ppm, 10 ppm from bottom to top; BGE - 20 mM sodium carbonate - sodium bicarbonate, pH 10.0, wavelength 214 nm).

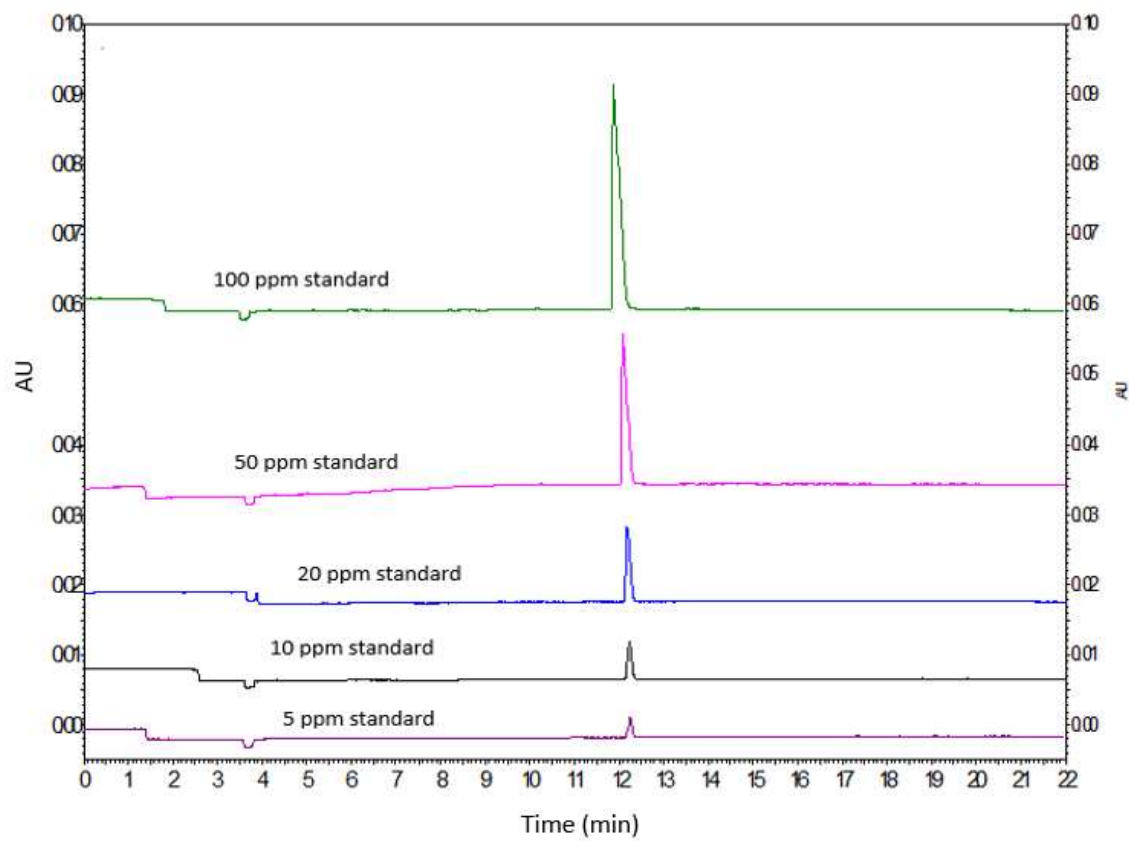

Fig A.2. Electropherogram of standard solutions of roxarsone (concentrations 5 ppm, 10 ppm, 20 ppm, 50 ppm, 100 ppm, BGE - 20 mM sodium carbonate bicarbonate buffer at pH 10.0, wavelength 214 nm).

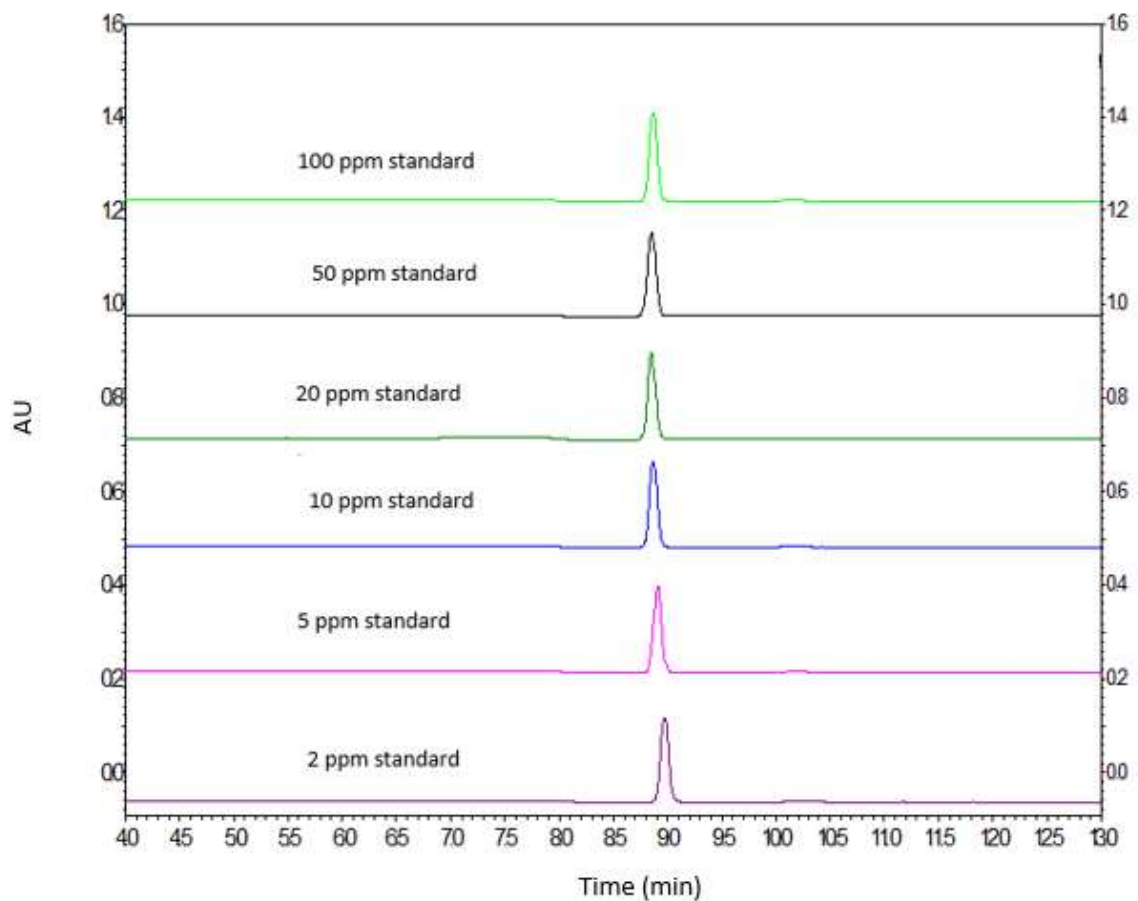

Fig. A.3. Electropherogram of nitarsone standard (2 ppm, 5 ppm, 10 ppm, 20 ppm, 50 ppm, 100 ppm) with BGE 60 mM sodium phosphate, pH 7.0, wavelength 214 nm). Although peaks migrated uniformly for the different concentrations, the peak areas did not increase accordingly.

Appendix B

Electropherograms of Samples

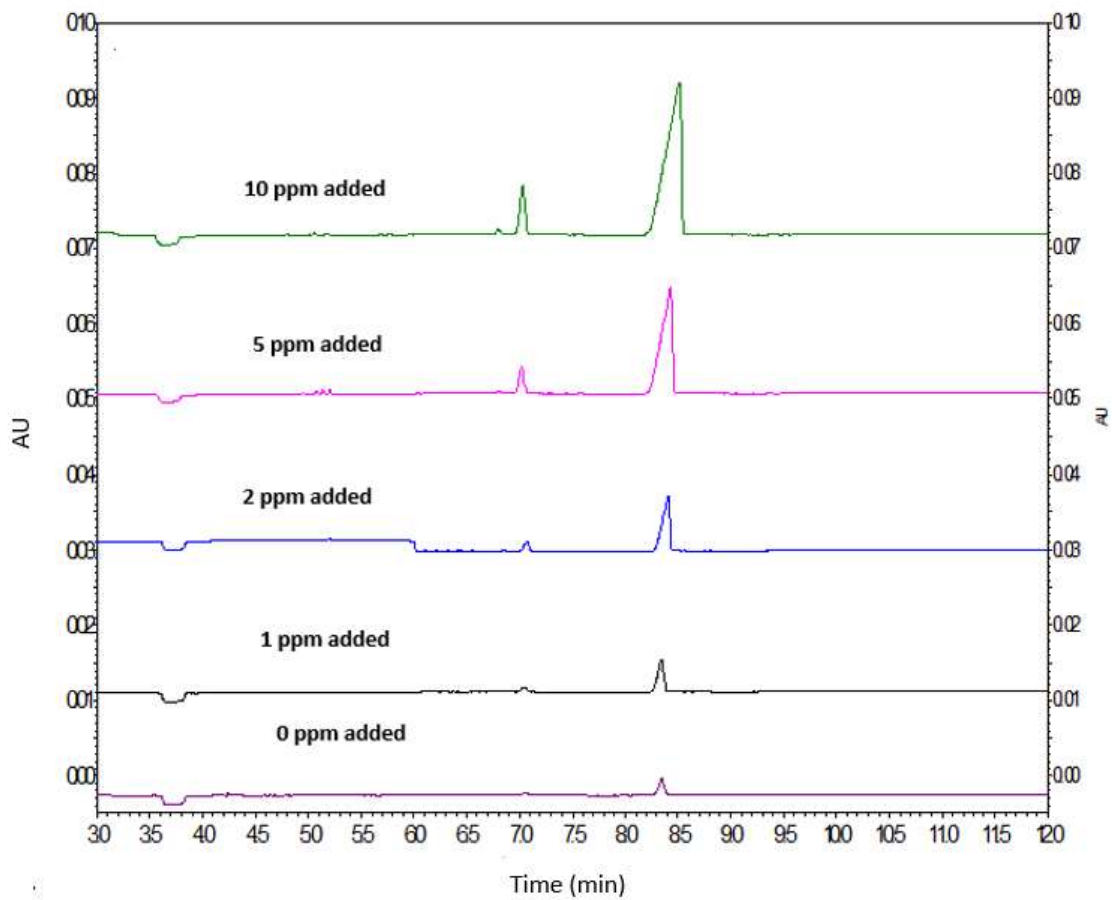

Fig A.4. Standard addition of nitarsone standard to well water A1 (BGE- 20 mM sodium carbonate bicarbonate buffer at pH 10.0, wavelength 214 nm).

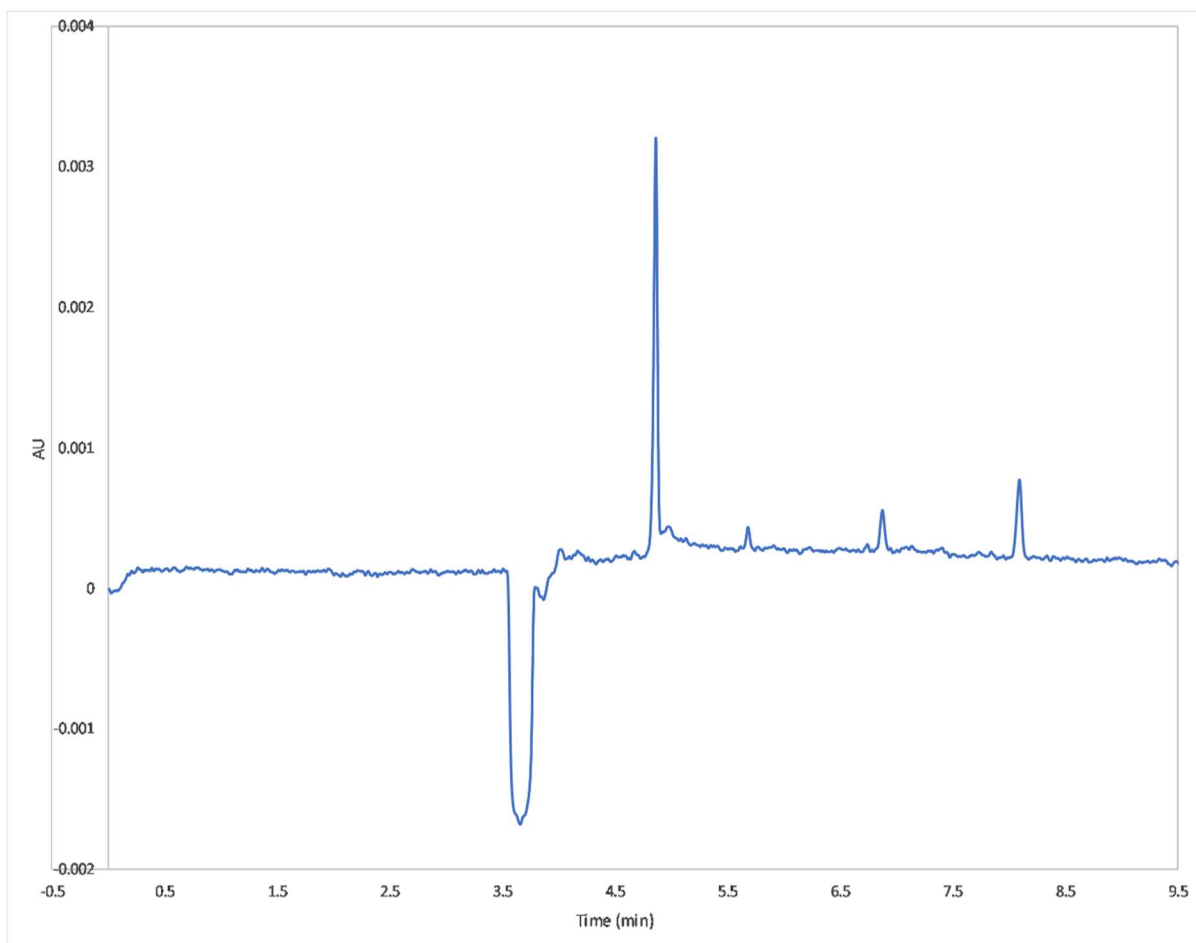

Fig A.5. Electropherogram of analysis of tap water 1A after solid phase extraction with C18 cartridge (BGE -20 mM sodium carbonate bicarbonate buffer at pH 10.0, wavelength 214 nm).

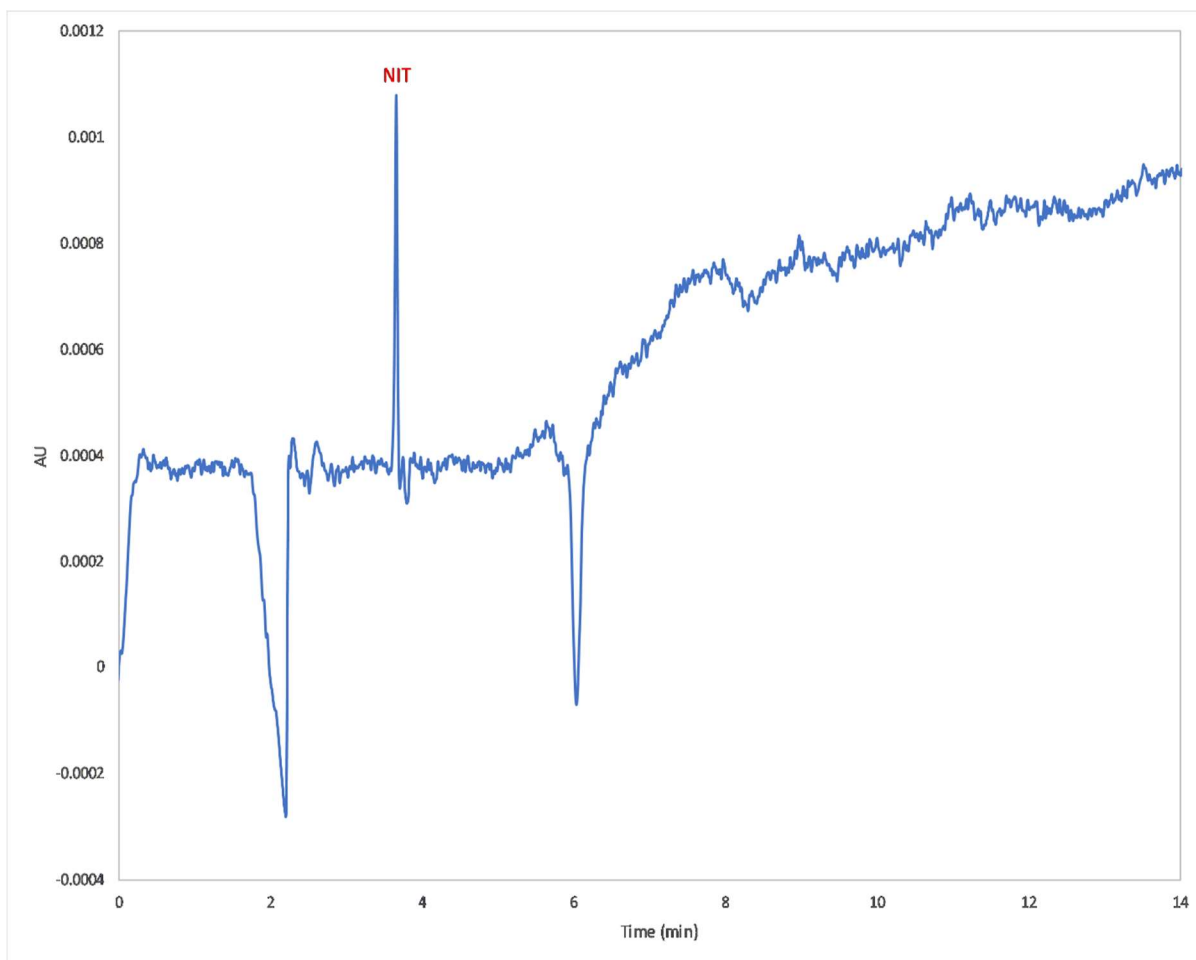

Fig A.6. Electropherogram of analysis of trough water A after solid phase extraction with C18 cartridge (BGE- 20 mM sodium carbonate bicarbonate buffer at pH 10.0, wavelength 214 nm).

Appendix C

Facts about arsenic and organoarsenicals

Table B.1. Estimates of lifetime average dose of arsenic species in adults and average daily dose in children (in micrograms per kilogram BW per day) resulting from consumption of turkey, based on sample characteristics (Nacham et al., 2017)

Sample characteristic	iAs	MA	DMA	Nitarsonsone
Adults				
Adult Antibiotic -free or USDA-certified Organic	0.00019	0.00075	0.00106	0.00003
Conventional, all	0.00028	0.00196	0.00122	0.00019
Conventional with prohibitory policy	0.00016	0.00014	0.00037	NA
Conventional, no known arsenic	0.00031	0.00260	0.00146	0.00026
No nitarsonsone detection	0.00045	0.00537	0.00222	0.00078
Child (4-30 months) of age				
Antibiotic-free or USDA- certified Organic	0.00073	0.00280	0.00390	0.00010
Conventional with prohibitory policy	0.0061	0.00051	0.00150	NA

Conventional, no known arsenical policy	0.00119	0.00950	0.00560	0.00093
No nitarsone detection	0.00077	0.00270	0.00350	NA
Positive nitarsone detection	0.00171	0.02039	0.00820	0.00300

Table B.2. Total arsenic concentration in various food groups from Canada ^(a) (WHO 2011).

Food category	Sample size	Mean (gAs/kg wet weight)	Range (g As/kg wet weight)
Milk and dairy products	89	3.8	<0.4 - 2.6
Meat and poultry	124	24.3	<1.3 – 536.0
Fish and shellfish	40	1662.4	77.0 – 4830.0
Soups	28	4.2	<0.2 – 11.0
Bakery goods and cereals	177	24.5	<0.1 – 365.0
Vegetables	262	7.0	<0.1 – 84.0
Fruit and fruit juices	176	4.5	<0.1 – 37.0
Fats and oils	21	19.0	<1.0-57.0
Sugar and candies	49	10.9	1.4 – 105
Beverages ^(b)	25	3.0	0.4 – 9.0
Miscellaneous ^(c)	33	12.5	<0.8 – 41.0

(a) Data from Dabeka et al., (1993); (b) includes: coffee, tea, soft drinks, wine and canned and bottled beer; (c) includes: bran muffins, muffins with and without raisins, gelatin desserts, raisins, baked beans, weiners, and raw and canned beets.

Table B.3. Comparison of two arsenical poultry drugs, roxarsone and nitarsone. Dosage rate and indication information are from the [Food and Drug Administration (FDA)] (Nachman et al., 2017).

Structure	Roxarsone	Nitarsone
		
Species	Broiler Chicken	Turkey
Dosage rate	22.7 45.5 g/ton	170.0 – 187.5g/tom
Purpose (indication) for use	Improved feed conversion, weight gain and pigmentation, prevention of coccidiosis	Prevention of blackhead disease
US FDA approved status	Withdrawn (February 2014)	Withdrawn (December 2015)

Table B.4. Human exposure to arsenic (WHO 2001).

Average 20 μ g/day from food and water

Background air is <0.1 μ g/L

Drinking water, usually < 5 μ g/L

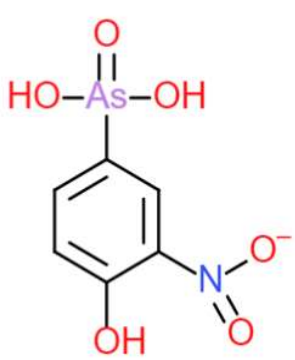
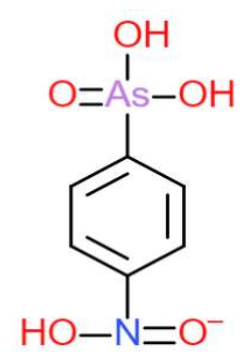
Food, usually <10 μ g/day

Country	Sample	Total As/day
Australia	Adult male	73 μ g
	2-year-old	17 μ g
Canada	Adult male	59 μ g
	1- 4 years old	15 μ g
USA	Adults	53 μ g
	0.5 – 2 years old	28 μ g

Table B.5. Concentration of Total Arsenic poultry Litter from Various Studies

Mean arsenic concentration (mg/kg dry weight)	SD (mg/kg)	Range (mg/kg)	Reference
29.8	13.89	14.9- 53.4	Ashjaei (2010)
			Ashjaei et al. (2011)
28.7	0.5		Garbarino et al. (2003)
29.0	3.0		Garbarino et al. (2003)
		0-77	Sims et al. (1994)
43.0	4.0		Moore et al. (1998)
35.1			Jackson et al. (1999)
16.8			Jackson et al. (2001)
45.0	9.57	1.2-39.4	Sims et al. (2002)
15.7		24-43	Jackson et al. (2003)
	7.80	11.1-36.1	Toor et al. (2007)
26.9	2.30		Han et al. (2004)
47.8	4.41		Arai et al. (2003)

Table B.6. Federal Drug Administration Tolerances for Arsenic Residues in Foods.

Production class	Product	Residue limit (ppm)
Poultry	Meat	0.5
	Meat by-product	2.0
	Liver	2.0
	Kidney	2.0

Source: 21 CFR 556.60

Table B.7. Estimates of inorganic, organic, and total arsenic intake assuming a mean concentration of 0.39 ppm total arsenic chicken liver tissue, and three possible ratios of liver to muscle arsenic concentrations.

Adjustment for ratio of liver arsenic to muscle arsenic	Percentile consumption	Chicken consumption (g/day)	Arsenic intake ($\mu\text{g}/\text{day}$)		
			Inorganic	Organic	Total
2.9	50 th	60	5.24	2.82	8.07
	95 th	200	17.48	9.41	26.90
	99 th	350	30.59	16.47	47.07
	99.9 th	612	53.50	28.81	82.30
4.2	50 th	60	5.24	1.95	5.57
	95 th	200	17.48	6.50	18.57
	99 th	350	30.59	11.38	32.50
	99.9 th	612	53.50	19.89	56.83

11.0	50 th	60	1.38	0.74	2.13
	95 th	200	4.61	2.48	7.09
	99 th	350	8.07	4.34	12.41
	99.9 th	612	14.10	7.59	21.70

Based on data from Alpharma Inc. (1999)

Table B.8. Comparison of total As concentration (geometric mean [GM]; 95% CI) and As speciation ($\mu\text{g kg}^{-1}$ fw) in chicken meat from this study and previous studies.

Study		Total As		As speciation				
		n	GM	n	IAs	DMA	ASA	ROX
Raw	Zhao et al., 2020	249	4.85	81	2.10	0.68	2.04	0.64
	Zhao et al., 2020	29	5.18	14	1.64	0.59	1.84	0.70
	Hu et al., 2017	32	25.5				-	
	Hu et al., 2016			8	3.10 \pm 1.61	1.80 \pm 0.48	3.79	0.41 \pm 0.04
Cooked	Zhao et al., 2020	249	7.27	81	2.52	1.25	3.79	0.74
	Nachman et al. 2013	140	3.0	78	1.1	3.5	-	0.6
		121	2.4	59	0.8	3.6	-	-
		19	10.2	19	2.3	3.2	-	1.3
